

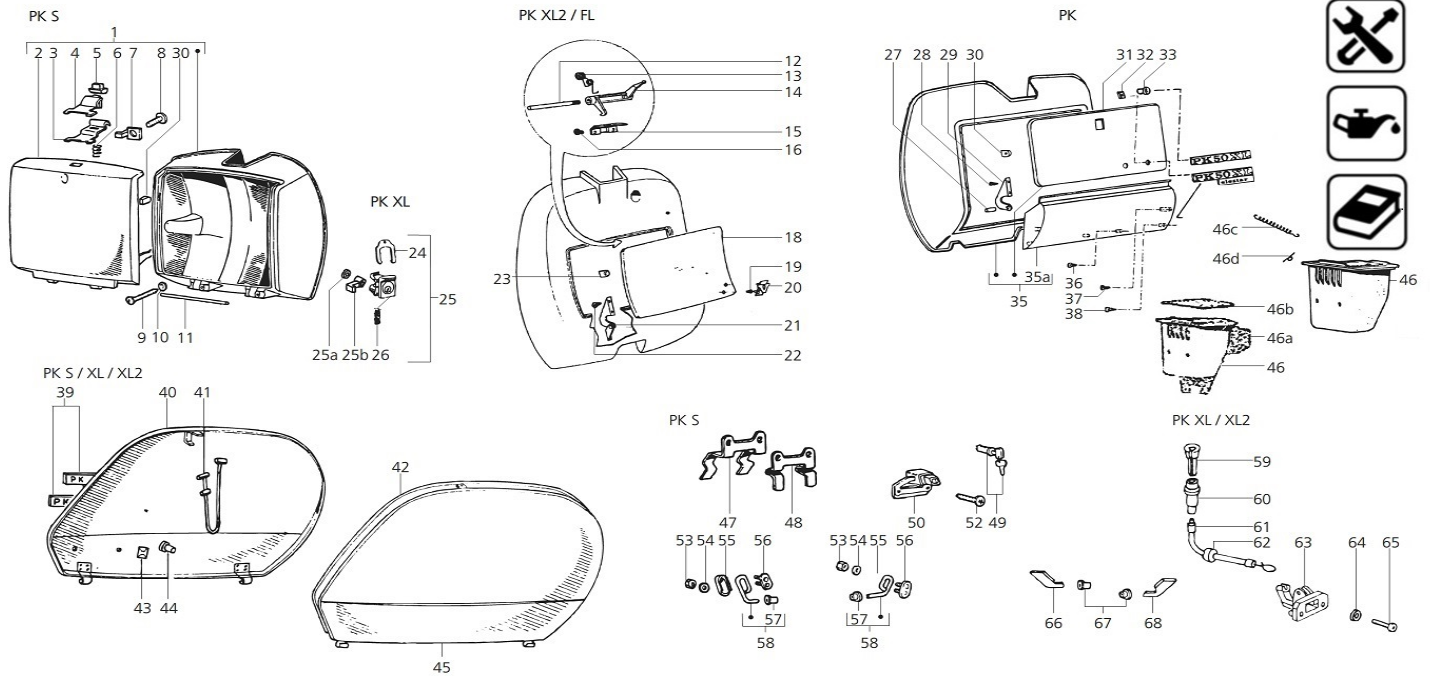































T15b Glovebox & Side Panel PK



| | | Prod.no. | Product name | Gross Price |
|---|---|----------|---|-------------|
| 2 |  | 76170000 | Glovebox Door for Vespa PK50 -125/S/SS/Automatica plastic, uncoated | 35,00 EUR |
| 3 |  | 21662000 | Actuation Lever SIP lower, glove box lock, for Vespa PK50-125/S/SS/Automatica, without lug, Grade A - perfect repair | 10,90 EUR |
| 4 |  | 21662100 | Actuation Lever top, glove box lock, for Vespa PK50-125/S/SS/Automatica, with catch | 6,90 EUR |
| 5 |  | 21662400 | Button SIP glove box, for Vespa PK50-125/S/SS/Automatica CNC machined | 6,90 EUR |
| 6 |  | 21662500 | Spring SIP glove box lock, for Vespa PK50-125/S/SS/Automatica Grade A - perfect repair | 3,20 EUR |
| 7 |  | 21662200 | Locking Lever SIP glove box, for Vespa PK50-125/S, steel, zinc plated, Grade A - perfect repair | 4,50 EUR |
| 8 |  | 12166800 | Sheet Metal Screw dust cap rear wheel, for Vespa/LML PX/T5/LML Star 125-200 2T/4T/ Star Deluxe /II 125 Automatica/CVT, rear wheel spoiler for Vespa T5, speedometer cover (top) for Vespa PK XL2/FL lock glove box for Vespa PK/S | 0,60 EUR |
| 9 |  | 18534000 | Screw 4,2x38 mm, raised head Ø 8,2mm, steel, zinc plated, horncover lower, for Vespa PK/S/XL/FL/HP Automatica, (2), tapping screw | 0,90 EUR |

| | | | | |
|---------|--|----------|---|-----------|
| 10 |  | 30540000 | Washer spoiler, top, M4 mm, Ø 4,3x9 mm, (th) 0,8mm, for Vespa T5 | 0,50 EUR |
| 12 |  | 25691200 | Bolt locking catch luggage panel, for Vespa PK XL2/FL | 1,75 EUR |
| 13 |  | 25691300 | Spring locking catch luggage panel, for Vespa Cosa/PK XL2/FL | 4,60 EUR |
| 14 |  | 25691100 | Catch glove box, for Vespa Cosa/PK XL2/FL | 6,00 EUR |
| 15 |  | 25242000 | Bracket glove box lock, for Vespa PK50-125 XL2/FL/HP/COSA 1-2/ET2/ET4/LX/LXV/Primavera/Sprint/GTS/GTS Super/GTV/GT 60/GT/GT L 50-300ccm also for APRILIA/DERBI/PIAGGIO 50-500ccm, 4T, AC/LC | 3,90 EUR |
| 16/38 |  | 84510000 | Screw 3,5x9,5 mm, cross recess, raised head, steel, zinc plated, glove box lower part/hinge-joint (outer top), glove box lock, for Vespa PK XL2/FL, seat lower part for Vespa PK XL/XL2/FL, handle bar cover for Vespa PKXL2/FL/N/ Automatica | 0,70 EUR |
| 19/32/4 |  | 18190900 | Securing Plate badge "Vespa" for Vespa all models rear light for Vespa all models, 15x8 mm, Ø 4-5 mm | 0,80 EUR |
| 20 |  | 25728600 | Badge "eVespa!", glove box for Vespa PK50XL FL/HP/N/Plurimatic/Automatica> tipo XL2/XL2 Elestart/ PK125 N/XL2 black/aluminium, aluminium | 10,90 EUR |
| 21 |  | 25695200 | Hinge-Joint glove box cover, right, for Vespa PK XL2/FL | 11,50 EUR |
| 21 |  | 25695300 | Hinge-Joint glove box cover, left, for Vespa PK XL2/FL | 12,90 EUR |















| | | | | |
|-------|---|-----------|--|-----------|
| 22/28 |  | 83720000 | Screw 3,5x16 mm, cross recess, raised head, steel, zinc plated, horncover/tray, for Vespa PK50-125 S/XL/XL2/PX 80-200/PE/Lusso/T5, also for LML Star 125- 200 2T /4T/Star 125 Deluxe/II Automatica/CVT, hinge glove box for Vespa PK XL/XL2/FL | 0,60 EUR |
| 23/30 |  | 21648600 | Rubber Buffer SIP glove box, for Vespa PK50-125/S/XL/XL2 /Automatica Grade A - perfect repair | 2,80 EUR |
| 24 |  | 73260000 | Securing Plate glove box lock, Ø (inner) 20 mm, for Vespa V50/PV/ET3/125/150/ PX/T5/VNB/VNC/VNL/VBC/VLA /VLB/ PK XL also for LML Star 125-200 2T /4T/ Star 125/II/Lite 4T Automatica/CVT | 1,60 EUR |
| 25 |  | 90000000 | Lock ZADI glove box, for Vespa 50-125 PV/ET3/P80-150X/PX 80 -200E/P200E/Super/Rally/180 SS for a true to original repair - grade A | 10,90 EUR |
| 25a |  | 177835000 | Toothed Lock Washer glove box lock, for Vespa V50/PV/ET3/PK XL /Rush | 1,90 EUR |
| 25b |  | 17896100 | Locking Lever glove box, for Vespa PK50-125 XL/N/Rush /Plurimatik/PX80-200 E Lusso / 98/MY/ 11/T5, also for LML Star 125-200 2T /4T/ Star 125/II/Lite 4T Automatica/CVT | 5,60 EUR |
| 26 |  | 73111000 | Spring glove box lock, for Vespa 50 Special/90-125/PV/ET3 /GT-TS/150 GL/GS/160 GS/180 SS/Rally/PX80-200/PE/Lusso also for LML Star 125-200 2T /4T/ Star 125/II/Lite 4T Automatica/CVT | 1,50 EUR |
| 27 |  | 23124300 | Bolt hinge-joint glove box cover, for Vespa PK XL/Rush | 2,10 EUR |
| 29 |  | 23124200 | Hinge-Joint glove box cover, left, for Vespa PK XL | 7,20 EUR |
| 34 |  | 93593000 | Badge "PK 50 XL", sidepanel for Vespa PK50 XL aluminium/red/black, fixation: 2 pins, pin distance: 75mm, 128x18 mm | 8,20 EUR |
| 35a |  | 23095100 | Lower Part glove box for Vespa PK XL/Rush | 47,00 EUR |
| 36 |  | 15994000 | Sheet Metal Screw 3,5x19 mm, cross recess, raised head, steel, zinc plated, black, rear light lens/indicator lens, for Vespa PX80- 200E Lusso/ 98, (2), mounting horn for Vespa PK/PX, (4), Glove box lower part for Vespa PK XL | 0,70 EUR |

| | | | | |
|----|---|----------|--|-----------|
| 37 |  | 84570000 | Sheet Metal Screw 4,2x19 mm, cross recess, raised head, steel, zinc plated, horncover lower, for Vespa PX/Lusso/T5/Cosa/PK, spoiler lower for Vespa T5, middle part legshield for Vespa PX Lusso glove box lower part PK XL | 1,00 EUR |
| 37 |  | 84571000 | Sheet Metal Screw 4,2x19 mm, cross recess, raised head, steel, zinc plated, black, horncover lower, for Vespa PX/Lusso/T5/Cosa/PK, spoiler lower for Vespa T5, middle part legshield for Vespa PX Lusso glove box lower part PK XL | 0,50 EUR |
| 39 |  | 93595000 | Badge "PK 125", sidepanel for Vespa PK 125 VMX1T black/aluminium, fixation: 2 pins, pin distance: 80mm | 7,90 EUR |
| 39 |  | 93589000 | Badge "PK 50", sidepanel for Vespa PK50 V5X1T black/aluminium, fixation: 2 pins, pin distance: 80mm, 95x17 mm | 8,30 EUR |
| 39 |  | 93594900 | Badge "Vespa 50N", sidepanel for Vespa PK 50-125 XL N/Nuovo black/aluminium, fixation: 3 pins, 170x21 mm | 12,90 EUR |
| 39 |  | 93594100 | Badge "PK80S elestart", sidepanel for Vespa PK80 S /Elestart V8X5T black/aluminium, fixation: 2 pins, pin distance: 80mm, 125x32 mm | 7,20 EUR |
| 39 |  | 93594300 | Badge "elestart", sidepanel for Vespa PK 50 S /Lusso/Elestart 3000001>3005233/ 125 S /Elestart 3000001>3006151, fixation: 2 pins, pin distance: 71mm, 95x15 mm | 7,50 EUR |
| 39 |  | 93594500 | Badge "automatica", sidepanel for Vespa PK50-125 Automatica black/aluminium, fixation: 3 pins, pin distance: 60mm, 160x15 mm | 7,90 EUR |
| 39 |  | 93595100 | Badge "PK125 S", sidepanel for Vespa PK 125 S /Elestart/Automatica black/aluminium, fixation: 2 pins, pin distance: 80mm, 132x17 mm | 9,00 EUR |
| 39 |  | 93591000 | Badge "PK 50S", sidepanel for Vespa PK50 S, V5X2T fixation: 2 pins, pin distance: 80mm | 7,60 EUR |
| 39 |  | 24019100 | Badge "PK 50S Lusso", sidepanel for Vespa PK50 S Lusso, V5X2T pin distance: 80mm | 14,50 EUR |

| | | | | |
|-------|---|----------|---|-----------|
| 39 |  | 93594400 | Badge "PK125 S elestart", sidepanel for Vespa PK125 S Elestart black/aluminium, fixation: 2 pins, pin distance: 80mm, 135x32 mm | 9,40 EUR |
| 39 |  | 93596100 | Sticker "Electronic", for Vespa PK50/80/125/S, black/green, l=69mm, w=20mm | 6,90 EUR |
| 39 |  | 93594200 | Badge "PK100S elestart", sidepanel for Vespa PK100 S /Elestart V9X1T black/aluminium, fixation: 2 pins, pin distance: 80mm, 135x32 mm | 7,50 EUR |
| 40 |  | 23451500 | Side Panel Door left for Vespa PK50-125/XL/XL2/FL/N/HP/Rush /Plurmatic/XLS black, with holes for badge | 29,00 EUR |
| 40 |  | 21691600 | Side Panel Door left for Vespa PK50-125/S/SS/ETS fits also automatica, black | 29,00 EUR |
| 40 |  | 234515C0 | Side Panel Door left for Vespa PK50-125/XL/XL2/FL/N/HP/Rush /Plurmatic/XLS chrome | 59,00 EUR |
| 40/45 |  | 22503410 | Insulation SIP PERFORMANCE universal, Puzzle w 290 mm, l 290 mm, h 10 mm, 4-parts | 20,90 EUR |
| 40/45 |  | 22503420 | Insulation SIP PERFORMANCE universal, Puzzle w 290 mm, l 290 mm, h 15 mm, 4-parts | 23,90 EUR |
| 41 |  | 19555600 | Securing Strap SIP sidepanel, for Vespa PK50-125/S/XL/XL2 also for Vespa Cosa/Cosa FL 125-200 | 4,00 EUR |
| 45 |  | 21691500 | Side Panel Door right for Vespa PK50-125/S/SS/ETS fits also automatica, black | 29,00 EUR |
| 45 |  | 23451600 | Side Panel Door right for Vespa PK50-125/XL/XL2/FL/N/HP /Rush/Plurmatic/XLS black | 29,00 EUR |
| 45 |  | 23471200 | Side Panel Door right for Vespa PKXL/XL2/FL foreign market, with indicator holder, NOS, may have minor scratch on surface | 85,00 EUR |
| 45 |  | 234516C0 | Side Panel Door right for Vespa PK50-125/XL/XL2/FL/N/HP /Rush/Plurmatic/XLS chrome | 59,00 EUR |
| 45 |  | 23316550 | Side Panel Door right for Vespa PK50 S (B) foreign market, with indicator holder, fits also Vespa PK50 -125S | 67,00 EUR |
| 46 |  | 21938300 | Tool Box OLYMPIA for Vespa PK50-125 S/XL/XL2/HP plastic | 13,90 EUR |

| | | | | |
|-------|---|----------|---|-----------|
| 46c |  | 12218000 | Spring glove box, for Vespa PX/T5/LML Star 125-200 2T/4T/ Star Deluxe/II 125 Automatica/CVT tool box/tool bag for Vespa V50/PV/ET3/PK | 2,00 EUR |
| 46d |  | 71638000 | Clamp spring glove box, for tool bag, for Vespa V50/PV/ET3 /PK 2 pcs | 3,40 EUR |
| 48 |  | 21725200 | Bracket battery cable, outside, for Vespa PK/S/XL/XL2 Elestart | 2,90 EUR |
| 49 |  | 16836000 | Cylinder Locks Set CIF for Vespa PKXL2/FL /Automatica /50HP 3 lock cylinders (one is longer for SiBa) | 17,00 EUR |
| 49 |  | 31130000 | Cylinder Locks ZADI ignition /seat/glove box, for Vespa PK50-125/S/XL/XL2/Automatica /PX80-200/PE/Lusso/T5/Cosa also for LML Star 125- 200 2T /4T/Star 125 Deluxe/II Automatica/CVT plastic, (1 lock cylinder, 2 keys) | 13,90 EUR |
| 49 |  | 16835400 | Cylinder Locks Set CIF ignit.. ion/seat/glove box/side panel, for Vespa PK50-125/S/XL /XL2/Automatica/PX80-200/PE /Lusso/ 98/T5/Cosa also for LML Star 125- 200 2T /4T/Star 125 Deluxe/II Automatica/CVT 5 lock cylinders, 2 keys | 24,90 EUR |
| 49 |  | 16835000 | Cylinder Locks Set ZADI igni.. ..tion/seat/glove box, for Vespa PK50-125/S/XL/XL2 /Automatica/PX80-200/PE /Lusso/T5/Cosa also for LML Star 125- 200 2T /4T/Star 125 Deluxe/II Automatica/CVT plastic, 3 lock cylinders, 2 keys | 16,00 EUR |
| 50 |  | 21526800 | Lock sidepanel, right/left, for Vespa PK/S/SS /Automatica /ETS w/o lock cylinder | 16,20 EUR |
| 51/64 |  | 30550000 | Washer stator plate, M5 mm, Ø a 10mm, Øi 5,3 mm, (th) 1mm, for Vespa V50/SS/SR/PX/Cosa screw mudguard/clutch arm for Vespa V50/R/S/ Special/90 /PV/ET3/PK/S//N/Rush/PK80 /PK125/ETS/PK/S/XL/XL2/FL, steel, zinc plated, 140 HV, mudguard/steering head cover for Vespa PK, screw speedometer mounting for Vespa V50/125/PV/ET3 | 0,50 EUR |

| | | | | |
|-------|---|----------|--|----------|
| 52/65 |  | 15737000 | Sheet Metal Screw 4,8x16 mm, cross recess, raised head Ø 9,5mm, steel, zinc plated, flywheel cover/pickup/horn, for Vespa PX/PE, lock side panel for Vespa PK/S/ XL/Rush/XL2/FL, cylinder cowling for Vespa V50/PV/ET3/PK/XL pickup for Vespa V100/ET3/PK/S /XL/XL2/FL | 0,90 EUR |
| 53 |  | 87171000 | Nut M5 mm, 10, steel, zinc plated, AF 8mm, h 4,0mm | 0,50 EUR |
| 53 |  | 39150000 | Nut M5 mm, stainless steel, AF 8mm, h 5,0mm, self-locking SIP floor board/handlebar lever, for Vespa V50/PK/XL/PX/T5, polyamide wedge | 0,50 EUR |
| 54 |  | 12532300 | Lock Washer screw holder side panel, Ø (outer) 10mm (inner) 5,5 mm, for Vespa PX/T5 stator plate for Vespa V50 Elestart, screw holder side panel for LML Star 125- 200 2T/4T holder side panel for Vespa PK/S, base plate cable handle bar for Vespa V50/PV/ET3 | 0,35 EUR |
| 57/67 |  | 24123500 | Bush sidepanel, for Vespa PK/S/SS/XL/XL2/FL/HP/Autom. | 4,50 EUR |
| 58 |  | 21793200 | Hinge-Joint sidepanel, rear, for Vespa PK/S | 8,60 EUR |
| 58 |  | 21533300 | Hinge-Joint sidepanel, front, for Vespa PK/S | 7,90 EUR |
| 59 |  | 23442200 | Pulling Knob SIP locking side panel, for Vespa PK50-125 XL /XL2/FL/HP/N/Automatica | 5,90 EUR |
| 60 |  | 23442100 | Sleeve nub locking side lid, SIP for Vespa PK50-125 XL/XL2/FL /HP/N/Automatica | 8,90 EUR |
| 61 |  | 12778000 | Cotter Pin brake arm, rear, for Vespa PK 50XL/N Plurimatic /80/125S Automatica lock side panel 3x25 mm | 1,70 EUR |
| 61 |  | 23449900 | Cable cable catch side panel for Vespa PK/XL/XL2/FL/HP /Automatica with sleeve and solder nipple, l (cable)=260mm, Ø 0,9mm/5,0 mm, l (sleeve)=190mm | 7,10 EUR |
| 62 |  | 18608400 | Grommet cable locking side panel, for Vespa PK/XL/XL2/FL /Automatica/50HP | 6,90 EUR |

| | | | | |
|-----|---|----------|---|------------|
| 63 |  | 23464800 | locking sidepanel, for Vespa PK50-125 XL/XL2/FL /HP/N/Automatica complete | 59,00 EUR |
| 68 |  | 24123100 | Hinge-Joint Punch sidepanel, front left/right, for Vespa PK PK/XL/XL2/Automatica w/o hole/thread for PK/S | 9,90 EUR |
| 97 |  | 610071M0 | Instruction Manual PIAGGIO Vespa PK 50 XL Italian | 16,90 EUR |
| 97 |  | 99412000 | Hand Book Klassische VESPA Motorroller - alle PK, PX, Cosa seit 1970" technics, service, repairs, German, 224 p., 650 colour photos and illustrations, 15th edition | 16,90 EUR |
| 98 |  | 14235000 | Brake Cleaner SIP 500ml, spray | 3,90 EUR |
| 98 |  | 14253000 | Contact Spray WD-40, 400ml | 8,50 EUR |
| 98 |  | 14080000 | Multi-Purpose Grease REPSTAR 400g | 5,50 EUR |
| 98 |  | 14230000 | Brake Cleaner MASTERCARE /REPSTAR 500ml, spray | 3,50 EUR |
| 99B |  | 20837529 | Set of Socket Spanners MINI 1/4", chrome-vanadium-steel, 160x8.. ..2x32 mm, plastic case, 23 pieces | 42,00 EUR |
| 99B |  | 90980000 | Tool Kit for PIAGGIO/Vespa all models flat/phillips headed screwdriver, spark pulg key 21/13, incl. bag | 18,90 EUR |
| 99B |  | 90970000 | Tool Bag PIAGGIO Vintage empty, w/o tools | 49,00 EUR |
| 99B |  | 208464B0 | Tool Kit SIP PORDOI, for Vespa 50-125/PV/ET3/PK50-125/S/XL /XL2, incl. black SIP Classic tool bag, for a first-class repair - grade AA | 239,00 EUR |
| 99B |  | 208464O0 | Tool Kit SIP PORDOI, for Vespa 50-125/PV/ET3/PK50-125/S/XL /XL2, incl. olive SIP Classic tool bag, for a first-class repair - grade AA | 245,00 EUR |
| 99B |  | 20837525 | Set of Socket Spanners JMP 1/4" + 1/2", chrome-vanadium-steel, plastic case, 82 parts | 149,00 EUR |
| 99B |  | CR432547 | Tool Box 25-piece | 19,90 EUR |

| | | | | |
|-----|--|----------|---|------------|
| 99B |  | MXMG05L | Gloves Mechanix The Original, black, unisex, size L, 60% nylon, 35% polyurethan, 5% elastane | 29,90 EUR |
| 99B |  | 20837520 | Screw Driver Set JMP slotted: 5mm/6mm/8mm, phillips: PH1/PH2/PH3, 6 parts | 35,00 EUR |
| 99B |  | 20837516 | Torque Key JMP 1/4", 5-25 Nm L=335 mm | 70,00 EUR |
| 99B |  | 61627000 | Socket Wrench "Mini" 1/4", lenght grip: 50mm | 35,00 EUR |
| 99B |  | 12194000 | Knee Pad SIP 435x195x30 mm, foam EVA, black /red | 10,20 EUR |
| 99B |  | 20837515 | Torque Key JMP 3/8", 20-110 Nm L=403 mm | 70,00 EUR |
| 99B |  | 20837522 | Combination Wrench Set JMP chrome-vanadium-steel, 6,7,8..,9,10,11,12,13,14,17,19,22 mm, 12-parts | 57,00 EUR |
| 99B |  | 20846600 | Tool Kit SIP CORTINA for Vespa 50-125/PV/ET3/PK50 -125/S/XL/XL2 w/o tool bag for a first-class repair - grade AA | 49,00 EUR |
| 99B |  | 20846200 | Tool Kit SIP PORDOI, universal, for Vespa all classic 2-stroke models incl. olive SIP Classic tool bag, for a first-class repair - grade AA | 265,00 EUR |
| 99B |  | 90982000 | Tool Kit wrench 7/8 8/11 regular, phillips screwdriver, spark plug wrench 21/13 | 15,00 EUR |
| 99B |  | 20846600 | Tool Kit SIP CORTINA for Vespa 50-125/PV/ET3/PK50 -125/S/XL/XL2 incl. olive SIP Classic tool bag for a first-class repair - grade AA | 75,00 EUR |
| 99B |  | 90970410 | Tool Bag SIP Classic, 640 mm, 270 cm, nylon, black, empty, w/o tools for a first-class repair - grade AA | 29,00 EUR |
| 99B |  | 20837521 | Open-End Wrench Set JMP chrome-vanadium-steel, 6/7, 8 /9, 10/11, 12/13, 14/15, 16 /17, 18/19, 20/22 mm, 8-parts | 35,00 EUR |
| 99B |  | 20837519 | Set of Socket Spanners JMP 1/2", chrome-vanadium-steel, plastic case, 29 parts | 99,00 EUR |

| | | | | |
|-----|---|----------|---|------------|
| 99B |  | 208466B0 | Tool Kit SIP CORTINA, for Vespa 50-125/PV/ET3/PK50-125/S/XL/XL2, incl. black SIP Classic tool bag, for a first-class repair - grade AA | 69,00 EUR |
| 99B |  | 20837517 | Allen Wrench Set JMP 1,5/2/2,5/3/4/5/6/8/10 mm, with ball end, 9 parts | 27,00 EUR |
| 99B |  | 20846400 | Tool Kit SIP PORDOI for Vespa 50-125/PV/ET3/PK50-125/S/XL/XL2 w/o tool bag for a first-class repair - grade AA | 219,00 EUR |
| 99B |  | 20837518 | Set of Socket Spanners JMP 1/4", chrome-vanadium-steel, plastic case, 46 parts | 85,00 EUR |
| 99B |  | 208462B0 | Tool Kit SIP PORDOI, universal, for Vespa all classic 2-stroke models incl. black SIP Classic tool bag, for a first-class repair - grade AA | 259,00 EUR |
| 99B |  | 20837523 | Pliers Set KNIPEX universal pliers/wire cutter /water pump pliers, 3 parts | 75,00 EUR |
| 99B |  | 12194100 | Floor Mat SIP 3 in 1 1210x420x30 mm, foam EVA, black/red, knee pad, cushion and floor mat all in one | 24,90 EUR |