

T19 Steering Column & Mudguard

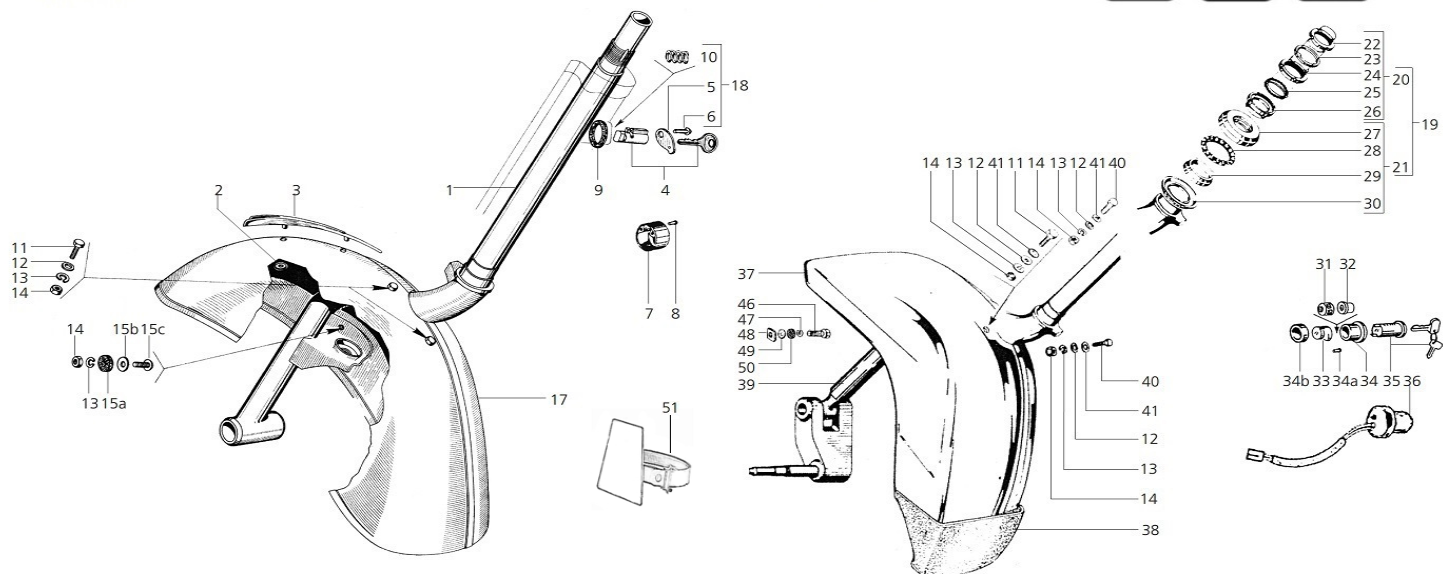





V50 / PV / ET3

PK / S / XL















| | | Prod.no. | Product name | Gross Price |
|---|--|----------|--|-------------|
| 1 | | 13347010 | Conversion Steering Column SIP PIAGGIO ZIP SP for converting to disc brakes for Vespa 50-125/PV/ET3 with suspension arm | 399,00 EUR |
| 1 | | 15232950 | Steering Column CIF for Vespa 50-125/PV/ET3 | 149,00 EUR |
| 1 | | 15232900 | Steering Column RMS for Vespa 50-125/PV/ET3 w/o suspension arm | 129,00 EUR |
| 1 | | 13337020 | Conversion Steering Column SIP PIAGGIO ZIP SP for converting to disc brakes for Vespa PK50-125/S/SS/XL /Automatica with suspension arm | 399,00 EUR |
| 1 | | 13337000 | Conversion Steering Column SIP Vespa PK50-125 S/SS/XL /Automatica for converting to disc brakes for Vespa 50-125/PV/ET3 for shock absorber 185mm, with suspension arm | 285,00 EUR |
| 2 | | 85508000 | Locking Washer mudguard crest, for Vespa 50-125/PV/ET3/125 V1 -TS/150 VL-Super/160 GS/180 SS/Rally dynamo cover for PIAGGIO /GILERA 2-4T/AC/LC | 1,50 EUR |
| 3 | | 75064300 | Mudguard Crest drop-shape, for Vespa 50/N/L/R/S/90/125 VMA/PV/ET3/VNB3-6/Super/150 VBA/VBB/Super/T4/GS VS5T 0059311 >, pin distance: 90mm, aluminium, chrome, l 160 mm | 15,90 EUR |





| | | | | |
|---|---|----------|---|-----------|
| 3 |  | 75062000 | Mudguard Crest PIAGGIO square, for Vespa PX125-200 E `98/MY /PX/PE, also for LML Star 125-200 2T /4T/Deluxe 2T/4S/Speedy /Stella pin distance: 95mm, plastic, chrome, l 195 mm, w 30 mm premium quality | 11,90 EUR |
| 3 |  | 75061400 | Mudguard Crest square, for Vespa 50 Special/125 GTR 2°/TS /150 Sprint V 2°/200 Rally, pin distance: 90mm, aluminium, polished, l 185 mm, w 20/27 mm | 12,20 EUR |
| 3 |  | 12470850 | Mudguard Crest square, for Vespa 50 Special/125 GTR 2°/TS /150 Sprint V 2°/200 Rally, pin distance: 90mm, aluminium, matt | 13,20 EUR |
| 3 |  | 75064200 | Mudguard Crest drop-shape, for Vespa 50/N/L/R/S/90/125 VMA/PV/ET3/VNB3-6/Super/150 VBA/VBB/Super/T4/GS VS5T 0059311 >, pin distance: 90mm, aluminium, polished, l 165 mm, as a very nice accessory | 15,90 EUR |
| 3 |  | 75064000 | Mudguard Crest drop-shape, for Vespa 50/N/L/R/S/90/125 VMA/PV/ET3/VNB3-6/Super/150 VBA/VBB/Super/T4/GS VS5T 0059311 >, pin distance: 90mm, aluminium, matt, l 165 mm | 9,00 EUR |
| 3 |  | 75061100 | Mudguard Crest square, for Vespa 50 Special/125 GTR 2°/TS /150 Sprint V 2°/200 Rally, pin distance: 90mm, black, l 185 mm, w 20 mm | 12,90 EUR |
| 4 |  | 16781000 | Key Blank ZADI steering lock, for Vespa for cylinder lock part no. 31121301/1678000/31122100 | 5,60 EUR |
| 4 |  | 16833000 | Cylinder Locks Set ZADI stee.. ..ring lock/glove box, for Vespa 50 R/125 ET3 44966->/ P80-150X/PX80-200-E/Lusso 1° /P150S/P200E l 38 mm, upper collar: 6mm, rear: 8mm | 21,90 EUR |
| 4 |  | 31120000 | Cylinder Locks ZADI steering lock, for Vespa 50 R/125 ET3 44966->/ P80-150X/PX80-200-E /Lusso 1°/P150S/P200E l 38 mm, plastic, upper collar: 6mm, rear: 8mm | 11,90 EUR |
| 4 |  | 16834100 | Cylinder Locks Set ZADI stee.. ..ring lock/glove box, for Vespa 50N 236001->/L ->580001 /S 34201 ->/Special/Elestart /SR/90 31301 ->/R/125 PV 028960->/ET3 ->44965/125 GT /Sprint 62685 ->/TS/GTR /Super/150 Sprint 077175-> /V./Rally l 39 mm, metal, upper collar: 4mm, rear: 8mm | 31,90 EUR |

| | | | | |
|------|---|----------|---|-----------|
| 4 |  | 31122000 | Cylinder Locks steering lock, for Vespa 50N->236000/L ->580000/S->34200/SS/90 ->31300/SS/125 PV->028959 /125 GT/Sprint->62684/GTR /Super/150 Sprint -> 077174 /Super/160 GS->55507/180SS l 31,5 mm, upper collar: 4mm, rear: 6mm | 15,70 EUR |
| 4 |  | 16780000 | Cylinder Locks ZADI steering lock, for Vespa 50N 236001->/L ->580001/S 34201 ->/Special /Elestart/SR/90 31301 ->/R /125 PV 028960->/ET3 ->44965 /125 GT/Sprint 62685 ->/TS /GTR/Super/150 Sprint 077175 ->/V./Rally l 39 mm, metal, upper collar: 4mm, rear: 8mm | 15,90 EUR |
| 4 |  | 31121301 | Cylinder Locks ZADI steering lock, for Vespa 50 R/125 ET3 44966->/ P80-150X/PX80-200E /Lusso 1°/P150S/P200E l 38 mm, upper collar: 6mm, rear: 8mm | 14,90 EUR |
| 4 |  | 31122300 | Cylinder Locks steering lock, for Vespa 50N 236001->/L ->580001/S 34201 ->/Special /Elestart/SR/90 31301 ->/R /125 PV 028960->/ET3 ->44965 /125 GT/Sprint 62685 ->/TS /GTR/Super/150 Sprint 077175 ->/V./Rally l 39 mm, Key NEIMAN, upper collar: 4mm, rear: 8mm | 17,90 EUR |
| 4 |  | 31122100 | Cylinder Locks ZADI steering lock, for Vespa 50N->236000/L ->580000/S->34200/SS/90 ->31300/SS/125 PV->028959 /125 GT/Sprint->62684/GTR /Super/150 Sprint -> 077174 /Super/160 GS->55507/180SS l 31,5 mm, upper collar: 4mm, rear: 6mm | 22,20 EUR |
| 4 |  | 16834000 | Cylinder Locks Set ZADI stee.. ..ring lock/glove box, for Vespa 50N 236001->/L ->580001 /S 34201 ->/Special/Elestart /SR/90 31301 ->/R/125 PV 028960->/ET3 ->44965/125 GT /Sprint 62685 ->/TS/GTR /Super/150 Sprint 077175-> /V./Rally l 39 mm, plastic, upper collar: 4mm, rear: 8mm | 32,00 EUR |
| 4/35 |  | 16835000 | Cylinder Locks Set ZADI igni.. ..tion/seat/glove box, for Vespa PK50-125/S/XL/XL2 /Automatica/PX80-200/PE /Lusso/T5/Cosa also for LML Star 125- 200 2T /4T/Star 125 Deluxe/II Automatica/CVT plastic, 3 lock cylinders, 2 keys | 16,00 EUR |





| | | | | |
|----|---|----------|---|----------|
| 5 |  | 31121000 | Steering Lock Cover for Vespa 50 N 236001 ->/L ->580001/S 34201 ->/Special/Elestart/SR /90 31301 ->/R/125 PV 028960 ->/ET3 ->44965/125 GT/Sprint 62685 ->/TS/GTR/Super/150 Sprint 077175->/V./Rally | 3,50 EUR |
| 6 |  | 31121100 | Rivet 3x8 mm, round head, steel, steering lock cover, for Vespa 50 N 236001 ->/L ->580001/S 34201 ->/Special /Elestart/SR/90 31301 ->/R /125 PV 028960->/ET3 ->44965 /125 GT/Sprint 62685 ->/TS /GTR/Super/150 Sprint 077175 ->/V./Rally, 1 rivet necessary, drop | 1,30 EUR |
| 6 |  | 17060500 | Rivet 3x8 mm, steering lock cover diamond, for Vespa V50N/L/S/SS/90/SS/PV /GTR/Super Sprint | 1,90 EUR |
| 7 |  | 17462800 | Cover steering lock, ZADI for Vespa 50 R/125 ET3 44966-> / P80-150X/PX80-200-E/Lusso 1°/P150S/P200E 2 rivets necessary, (art. no. 17462900) | 3,90 EUR |
| 8 |  | 17462900 | Rivet 2,5x13,5 mm, ZADI lock cover art. no. 17462800, 2 pcs necessary, does not fit Art.: 31121000! | 1,30 EUR |
| 9 |  | 24412700 | Sealing Ring steering lock for Vespa V50/PV/ET3/ Sprint /Rally/GT/GTR/PX/P150S Grade B - decent repair | 2,70 EUR |
| 9 |  | 12229600 | Sealing Ring RMS steering lock for Vespa V50/PV/ET3/ Sprint /Rally/GT/GTR/PX/P150S | 3,20 EUR |
| 10 |  | 15219500 | Spring RMS lock cylinder, for Vespa V50/PV/ ET3/PX/APE 50/TMP50/MVP600/P60 fits art. no. 31120000 /16780000 | 1,10 EUR |
| 11 |  | 21057000 | Screw M5x20 mm, hexagonal, AF 8mm, steel, zinc plated, 8.8, mudguard, for Vespa V50/PV/ET3/PK | 0,90 EUR |
| 12 |  | 30550000 | Washer stator plate, M5 mm, Ø a 10mm, Øi 5,3 mm, (th) 1mm, for Vespa V50/SS/SR/PX/Cosa screw mudguard/clutch arm for Vespa V50/R/S/ Special/90 /PV/ET3/PK/S//N/Rush/PK80 /PK125/ETS/PK/S/XL/XL2/FL, steel, zinc plated, 140 HV, mudguard/steering head cover for Vespa PK, screw speedometer mounting for Vespa V50/125/PV/ET3 | 0,50 EUR |

| | | | | |
|-----|---|----------|--|-----------|
| 13 |  | 80004000 | Spring Washer stator plate, M5 mm, Ø 5,1x9,2 mm, (th) 1,2mm, for Vespa PX/Cosa ignition coil/supply coil for Vespa V50/90/100/PV, spring steel, zinc coated, pickup for Vespa PK50(I)/S/XL /Rush, mudguard for Vespa V50/PV/ET3 | 0,40 EUR |
| 13 |  | 80105000 | Locking Washer NORD-LOCK M5 mm, Ø 9x5,4 mm, (th) 1,8mm, zinc plated, 2-parts | 0,80 EUR |
| 14 |  | 87171000 | Nut M5 mm, 10, steel, zinc plated, AF 8mm, h 4,0mm | 0,50 EUR |
| 14 |  | 39150000 | Nut M5 mm, stainless steel, AF 8mm, h 5,0mm, self-locking SIP floor board/handlebar lever, for Vespa V50/PK/XL/PX/T5, polyamide wedge | 0,50 EUR |
| 15a |  | 99335000 | Spacer mudguard, SIP sideways, Ø 18x6,4x5 mm, for Vespa 50-125/PV/ET3 plastic, for a first-class repair - grade AA | 2,40 EUR |
| 15b |  | 25363000 | Washer screw mudguard, sideways, outside, M5,2x14x0,6 mm, for Vespa Rally/PX/T5 handle bar lever (lower) for Vespa V50/PV/ET3/PK/PX/T5, mudguard (top) for Vespa PK, headlight lever adjustment for Vespa V50 Special /Elestart | 1,40 EUR |
| 15c |  | 50411130 | Screw M5x15 mm, raised head Ø13mm, LML mudguard sideways, for Vespa 50-125 PV/ET3/PX/125 VNA/VNB/Super/TS/150 VBA/VBB /Super/Sprint V./Rally, for LML Star 125- 200 2T/4T /Star Lite 125, Grade C - low-priced repairs | 1,70 EUR |
| 15c |  | 25361900 | Screw M5x16 mm, raised head Ø13mm, PASCOLI mudguard sideways, for Vespa 50-125 PV/ET3/PX/125 VNA/VNB/Super/TS/150 VBA/VBB /Super/Sprint V./Rally, also for LML Star 125-200 2T /4T/ Star Lite 125, for a true to original repair - grade A | 4,70 EUR |
| 15c |  | 25361400 | Screw M5x12 mm, raises head Ø 12,5mm, stainless steel, mudguard, for Vespa 50-125 PV/ET3/PX/125 VNA/VNB/Super/TS/150 VBA/VBB /Super/Sprint V./Rally, Grade A - perfect repair | 2,90 EUR |
| 17 |  | 76010000 | Mudguard for Vespa 50-125/PV /ET3 metal, black | 35,00 EUR |



| | | | | |
|----|---|----------|---|-----------|
| 17 |  | 76013000 | Mudguard PLC for Vespa 50-125 /PV/ET3 GRP, for mounting a PK fork, for a better drivability | 75,00 EUR |
| 17 |  | 76012000 | Mudguard for Vespa 50-125/PV /ET3 oiled metal, premium quality | 59,00 EUR |
| 17 |  | 90712570 | Mudguard CRIMAZ for Vespa 50-125/PV/ET3 GRP, for ZIP steering column in Smallframe | 82,00 EUR |
| 17 |  | 75505000 | Mudguard for Vespa 50 SS/90 SS oiled metal, premium quality | 79,00 EUR |
| 17 |  | 76033100 | Mudguard for Vespa PK50-125/S oiled metal | 55,00 EUR |
| 18 |  | 17060400 | Steering Lock Cover for Vespa 50N->236000/L->580000/S->34200 /SS/90->31300/SS/125 PV ->028959/125 GT/Sprint ->62684/GTR/Super/150 Sprint -> 077174/Super/160 GS ->55507/180SS incl. 1 rivet, Ø=2,6mm | 3,70 EUR |
| 19 |  | 90120000 | Steering Head Bearing Set upper/lower for Vespa 50-125/PV/ET3/PK50 -125/S/SS/XL/125 GT-TS/ 150 Sprint/V/Super/160 GS/180 SS /Rally/PX80-200/PE/Lusso/'98 /MY/'11/T5/Cosa, also for GILERA/PIAGGIO 50 -300ccm Automatik Ø bearing shell frame top 31x36,55/42,9/ bearing shell frame lower 36,7x64/ bearing shell steering column 35x46,8 mm, w/o dust cover, Grade C - low-priced repairs | 22,90 EUR |
| 20 |  | 90102000 | Steering Head Bearing Set top for Vespa 50-125/PV/ET3/PK50 -125/S/SS/XL/125 GT-TS/ 150 Sprint/V/Super/160 GS/180 SS /Rally/PX80-200/PE/Lusso/'98 /MY/'11/T5/Cosa, also for GILERA/PIAGGIO 50 -300ccm Automatik PIAGGIO, Ø bearing shell frame top 31x36,55-42,90mm/ Ø ball 4,0 mm, w/o nut steering head/circlip, Grade A - perfect repair | 16,50 EUR |

| | | | | |
|----|---|----------|--|------------|
| 20 |  | 90100000 | Steering Head Bearing Set top for Vespa 50-125/PV/ET3/PK50 -125/S/SS/XL/125 GT-TS/ 150 Sprint/V/Super/160 GS/180 SS /Rally/PX80-200/PE/Lusso/'98 /MY/'11/T5/Cosa, also for GILERA/PIAGGIO 50 -300ccm Automatik Ø bearing shell frame top 31x36,55-42,90mm/ Ø ball 3,2 mm, incl. nut steering head /circlip | 16,90 EUR |
| 21 |  | 90126000 | Steering Head Bearing Set upper/lower for Vespa 50-125/PV/ET3/PK50 -125/S/SS/XL/125 GT-TS/ 150 Sprint/V/Super/160 GS/180 SS /Rally/PX80-200/PE/Lusso/'98 /MY/'11/T5/Cosa, also for GILERA/PIAGGIO 50 -300ccm Automatik taper roller bearing, incl. dust cover, RACE-Tuning, for highest demands Grade AA - first-class repair | 119,00 EUR |
| 21 |  | 90115000 | Steering Head Bearing Set lower for Vespa 50-125/PV/ET3/PK50 -125/S/SS/XL/125 GT-TS/ 150 Sprint/V/Super/160 GS/180 SS /Rally/PX80-200/PE/Lusso/'98 /MY/'11/T5/Cosa, also for GILERA/PIAGGIO 50 -300ccm Automatik PIAGGIO, Ø bearing shell frame top 31x36,55-42,90mm/ Ø ball 6,35 mm, incl. dust cover, Grade A - perfect repair | 17,90 EUR |
| 21 |  | 90110000 | Steering Head Bearing Set lower for Vespa 50-125/PV/ET3/PK50 -125/S/SS/XL/125 GT-TS/ 150 Sprint/V/Super/160 GS/180 SS /Rally/PX80-200/PE/Lusso/'98 /MY/'11/T5/Cosa, also for GILERA/PIAGGIO 50 -300ccm Automatik Ø bearing shell frame lower 36,7x64/ bearing shell steering column 35x46,8/ dust cover steering column 35x63 mm, incl. dust cover, Grade B - decent repair | 15,50 EUR |

| | | | | |
|----|---|----------|--|-----------|
| 21 |  | 90124000 | Steering Head Bearing Set upper/lower for Vespa 50-125/PV/ET3/PK50 -125/S/SS/XL/125 GT-TS/ 150 Sprint/V/Super/160 GS/180 SS /Rally/PX80-200/PE/Lusso/'98 /MY/'11/T5/Cosa, also for GILERA/PIAGGIO 50 -300ccm Automatik RMS, Ø bearing shell frame top 31x36,55/42,9/ bearing shell frame lower 36,7x64/ bearing shell steering column 35x46,8 mm, incl. dust cover, Grade B - decent repair | 29,00 EUR |
| 22 |  | 53419020 | Nut steering head bearing /column for Vespa 50-125/PV/ET3/PK50 -125/S/SS/XL/125 VM/VN/VNA -TS/150 VL/VB/GS/VBA-T4 /160 GS/180 SS/Rally/PX80-200/PE /Lusso/'98/MY/'11, also for LML Star 125-200 2T /4T/ Star 125/II/Lite 4T Automatica/CVT LML, Grade C - low-priced repairs | 2,90 EUR |
| 22 |  | 87420000 | Nut steel, yellow zinc plated, h 7,0mm, SIP, steering head bearing /column, top, for Vespa PK50-125 XL FL/HP/N /XL2/T5/Cosa | 7,10 EUR |
| 22 |  | 11109000 | Nut h 5,2mm, steering head bearing/column, top, for Vespa 50-125/PV/ET3/PK50 -125/S/SS/XL/125 VM/VN/VNA -TS/150 VL/VB/GS/VBA-T4 /160 GS/180 SS/Rally/PX80-200/PE /Lusso/'98/MY/'11, (0), also for LML Star 125-200 2T /4T/ Star 125/II/Lite 4T Automatica/CVT, (0) Grade A - perfect repair | 4,90 EUR |
| 23 |  | 22957000 | Spacer steering head, SIP for Vespa PK50-125 XL/FL/HP/N /XL2/T5/Cosa 2 lugs | 9,90 EUR |
| 23 |  | 37510000 | Locking Washer steering head bearing, top, Ø 40x30x2,6 mm, for Vespa 50-125/PV/ET3/PK50 -125/S/SS/XL/125 VM/VN/VNA -TS/150 VL/VB/GS/VBA-T4 /160 GS/180 SS/Rally/PX80-200/PE /Lusso/'98/MY/'11 also for LML Star 125-200 2T /4T/ Star 125/II/Lite 4T Automatica/CVT, Grade A - perfect repair | 2,90 EUR |













| | | | | |
|-----|---|----------|---|-----------|
| 23a |  | 31122200 | Cylinder Locks NEIMAN steering lock, for Vespa 50N->236000/L ->580000/S->34200/SS/90 ->31300/SS/125 PV->028959 /125 GT/Sprint->62684/GTR /Super/150 Sprint -> 077174 /Super/160 GS->55507/180SS l 31,5 mm, Key NEIMAN, upper collar: 4mm, rear: 6mm | 17,90 EUR |
| 24 |  | 53419370 | Nut LML, steering head bearing /column, top, for Vespa 50-125/PV/ET3/PK50 -125/S/SS/XL/125 VM/VN/VNA -TS/150 VL/VB/GS/VBA-T4 /160 GS/180 SS/Rally/PX80-200/PE /Lusso/'98/MY/'11, also for LML Star 125-200 2T /4T/ Star 125/II/Lite 4T Automatica/CVT, Grade C - low-priced repairs | 7,20 EUR |
| 24 |  | 22660000 | Nut steering head bearing/column, top, for Vespa 50-125/PV/ET3/PK50 -125/S/SS/XL/125 VM/VN/VNA -TS/150 VL/VB/GS/VBA-T4 /160 GS/180 SS/Rally/PX80-200/PE /Lusso/'98/MY/'11/T5/Cosa, also for PIAGGIO 50-300ccm, for a first-class repair - grade AA | 7,10 EUR |
| 25 |  | 90090000 | Steering Head Bearing top for Vespa 50-125/PV/ET3/PK50 -125/S/SS/XL/XL2/125 VNB3 061001->/GT/GTR/TS/Super/150 VBB1 82820->/VGLB 041665-> /Sprint/V/Super/160 GS/180 SS/Rally/PX80-200/PE/Lusso /'98/MY/'11/T5/Cosa/LML 2-4T, also for PIAGGIO 50-300ccm Automatik Ø ball 3,2 mm, 1/8" | 3,00 EUR |
| 26 |  | 52418410 | Bearing Shell steering head bearing frame top for Vespa 50-125/PV/ET3/PK50 -125/S/SS/XL/XL2/125 GT-TS/ 150 Super/Sprint/V/160 GS /180 SS/Rally/PX80-200/PE /Lusso/'98/MY/'11/T5/Cosa, also for LML Star 125-200 2T /4T/ Star 125/II/Lite 4T Automatica/CVT also for PIAGGIO 50-300ccm Automatik LML, Grade C - low-priced repairs | 8,90 EUR |





| | | | | |
|----|---|----------|--|-----------|
| 26 |  | 56641000 | Bearing Shell steering head bearing frame top for Vespa 50-125/PV/ET3/PK50 -125/S/SS/XL/XL2/125 GT-TS/ 150 Super/Sprint/V/160 GS /180 SS/Rally/PX80-200/PE /Lusso/'98/MY/'11/T5/Cosa, also for LML Star 125-200 2T /4T/ Star 125/II/Lite 4T Automatica/CVT also for PIAGGIO 50-300ccm Automatik 43x37/ 31x12 mm, for a first-class repair - grade AA | 12,20 EUR |
| 27 |  | 91530000 | Bearing Shell steering head bearing frame lower for Vespa 50-125/PV/ET3/PK50 -125/S/SS/XL/XL2/125 GT-TS/ 150 Super/Sprint/V/160 GS /180 SS/Rally/PX80-200/PE /Lusso/'98/MY/'11/T5/Cosa, also for PIAGGIO 50-300 Automatik also for LML Star 125- 200 2T /4T/Star 125 Deluxe/II Automatica/CVT Grade A - perfect repair | 7,50 EUR |
| 27 |  | 52418700 | Bearing Shell steering head bearing frame lower for Vespa 50-125/PV/ET3/PK50 -125/S/SS/XL/XL2/125 GT-TS/ 150 Super/Sprint/V/160 GS /180 SS/Rally/PX80-200/PE /Lusso/'98/MY/'11/T5/Cosa, also for PIAGGIO 50-300 Automatik also for LML Star 125- 200 2T /4T/Star 125 Deluxe/II Automatica/CVT LML, Grade C - low-priced repairs | 6,20 EUR |
| 28 |  | 77023000 | Steering Head Bearing lower for Vespa 50-125/PV/ET3/PK50 -125/S/SS/XL/XL2/125 VNB3 061001->/GT/GTR/TS/Super/150 VBB1 82820->/VGLB 041665-> /Sprint/V/Super/160 GS/180 SS/Rally/PX80-200/PE/Lusso /'98/MY/'11/T5/Cosa, also for GILERA/PIAGGIO 50-300 Automatik also for LML Star 125- 200 2T /4T/Star 125 Deluxe/II Automatica/CVT Grade A - perfect repair | 4,90 EUR |















| | | | | |
|----|---|----------|---|-----------|
| 29 |  | 53419380 | Bearing Shell steering head bearing lower for Vespa 50-125/PV/ET3/PK50 -125/S/XL/XL2/125 GT-TS/150 GL-Super/200 Rally/PX80-200 /PE/Lusso/'98/MY/'11/T5/Cosa, also for PIAGGIO 50-300 Automatic also for LML Star 125- 200 2T /4T/Star 125 Deluxe/II Automatica/CVT LML, Grade C - low-priced repairs | 8,90 EUR |
| 29 |  | 91500000 | Bearing Shell steering head bearing/column lower for Vespa 50-125/PV/ET3/PK50 -125/S/SS/XL/XL2/125 GT-TS/150 Super/Sprint/V/160 GS /180 SS/Rally/PX80-200/PE /Lusso/'98/MY/'11/T5/Cosa, also for GILERA/PIAGGIO 50-300 Automatic also for LML Star 125- 200 2T /4T/Star 125 Deluxe/II Automatica/CVT Grade A - perfect repair | 12,90 EUR |
| 30 |  | 91550000 | Dust Cover Shell steering column lower for Vespa 50-125/PV/ET3/PK50 -125/S/SS/XL/XL2/125 GT-TS/150 Super/Sprint/V/160 GS /180 SS/Rally/PX80-200/PE /Lusso/'98/MY/'11/T5/Cosa, also for GILERA/PIAGGIO 50 -300ccm Automatic also for LML Star 125- 200 2T /4T/Star 125 Deluxe/II Automatica/CVT 63x35 mm, Grade A - perfect repair | 3,70 EUR |
| 31 |  | 25690900 | Distance Piece switch steering lock, SIP for Vespa PK50 XL FL/HP/N Plurimatic/XL2/PK125 N /Automatica/XL2 for LML Sensation | 11,90 EUR |
| 32 |  | 25690500 | Bush steering lock, for Vespa PK50 XL FL/HP/N Plurimatic/XL2 /PK125 N/Automatica/XL2 for LML Sensation Grade B - decent repair | 7,90 EUR |
| 33 |  | 17856200 | Lock Bar steering lock, for Vespa PK/S/XL/ PX80-200E Lusso /'98/MY/T5 also for LML Star 125-200 2T /4T/ Star 125/II/Lite 4T Automatica/CVT Grade A - perfect repair | 4,90 EUR |
| 33 |  | 52418260 | Lock Bar LML steering lock, for LML Star 125-200 2T/4T/ Star 125/II/Lite 4T Automatica/CVT also for Vespa PK/S/XL/PX80 -200E Lusso/'98/MY/T5 Grade C - low-priced repairs | 3,50 EUR |











| | | | | |
|-----|---|----------|---|-----------|
| 34 |  | 29777600 | Lock Body PIAGGIO for Vespa PK 50 XL FL/HP/N/XL2/Cosa for PIAGGIO Free/Quartz/Sfera /Skipper/SKR | 8,10 EUR |
| 34 |  | 29777700 | Lock Body RMS steering lock, for PIAGGIO/Vespa PK/S/XL/PX Lusso/Ape FL/FL2 | 7,20 EUR |
| 34a |  | 17855900 | Spring steering lock, for Vespa PX80-200E Lusso/ 98/MY /T5 also for LML Star 125-200 2T /4T/ Star 125/II/Lite 4T Automatica/CVT | 0,50 EUR |
| 34b |  | 47122870 | Gasket LML steering lock for LML Star 125-200 4T/Star Deluxe 125-150 4S/Speedy also for Vespa PK/S/XL/PX80 -200E Lusso/ 98/MY/T5 Grade C - low-priced repairs | 1,20 EUR |
| 34b |  | 21908400 | Gasket steering lock for Vespa PK/S/XL/ PX80-200E Lusso/ 98 /MY/T5 also for LML Star 125-200 2T /4T/ Star 125/II/Lite 4T Automatica/CVT Grade A - perfect repair | 2,00 EUR |
| 35 |  | 16782000 | Key Blank NEIMAN steering lock, for Vespa for glove box, steering lock, side panel | 9,00 EUR |
| 35 |  | 31130000 | Cylinder Locks ZADI ignition /seat/glove box, for Vespa PK50-125/S/XL/XL2/Automatica /PX80-200/PE/Lusso/T5/Cosa also for LML Star 125- 200 2T /4T/Star 125 Deluxe/II Automatica/CVT plastic, (1 lock cylinder, 2 keys) | 13,90 EUR |
| 35 |  | 16835400 | Cylinder Locks Set CIF ignit.. ion/seat/glove box/side panel, for Vespa PK50-125/S/XL /XL2/Automatica/PX80-200/PE /Lusso/ 98/T5/Cosa also for LML Star 125- 200 2T /4T/Star 125 Deluxe/II Automatica/CVT 5 lock cylinders, 2 keys | 24,90 EUR |
| 35 |  | 25771000 | Key Blank PIAGGIO ignition lock/seat/glove box, for Vespa PK50-125/S/XL/XL2/ PX80-200/PE/Lusso/T5/Cosa l 32 mm, w 7,8 mm | 7,10 EUR |
| 36 |  | 23102400 | Plug ignition lock, for Vespa PK50-125/S/SS/XL/XL2/ETS/PX80 -200 E Lusso/T5 with e-start 4 cables, with/red/green/black | 22,90 EUR |
| 36 |  | 17859300 | Plug ignition lock, for Vespa PK50-125/S/SS/XL/XL2/ETS/PX80 -200 E Lusso/T5 without e-start 2 cables | 18,20 EUR |

| | | | | |
|------|---|----------|---|------------|
| 36 |  | 50411530 | Grub Screw LML plug ingnition lock, for LML Star 125-200 4T/Star Deluxe 125-150 4S/Speedy, also for Vespa PK/S/XL/PX80 -200E Lusso/ 98/MY/T5 | 0,50 EUR |
| 36 |  | 18515000 | Grub Screw M5x8 mm, inner hexagonal, for plug ignition lock, for Vespa PK/S/SS/XL/PX/Lusso /T5 | 0,60 EUR |
| 36 |  | 29158200 | Plug ignition lock, for Vespa PX125 -200 E Lusso with battery | 24,00 EUR |
| 37 |  | 76060000 | Mudguard for Vespa PK50-125 XL FL/HP/XL2/Automatica plastic, black | 45,00 EUR |
| 37 |  | 76030000 | Mudguard for Vespa PK50-125/S /XL metal, black | 45,00 EUR |
| 37 |  | 75021100 | Mudguard SIP Garelli for Vespa PK50-125/S/XL/XL2/ETS /Automatica metal, chrome, mit Halter für Trommelbremse, black as a very nice accessory | 65,00 EUR |
| 38 |  | 26630800 | Mud Flap mudguard, for Vespa PKXL FL/HP/N/XL2/Automatica | 13,90 EUR |
| 39 |  | 21549500 | Steering Column RMS for Vespa PK50/S/SS/XL (I) w/o suspension arm | 145,00 EUR |
| 39 |  | 13347000 | Steering Column RMS for Vespa PK50-125 XL2/FL/HP /Automatica with suspension arm | 229,00 EUR |
| 39/1 |  | 13333000 | Steering Column RMS for Vespa PK50-125/S/SS/XL/Automatica with suspension arm | 235,00 EUR |
| 40 |  | 21058000 | Screw M5x30 mm, hexagonal, AF 8mm, steel, zinc plated, 8.8, mudguard front/rear, for Vespa PK | 0,90 EUR |
| 41 |  | 80106000 | Locking Washer NORD-LOCK M6 mm, Ø 10,8x6,5 mm, (th) 1,8mm, zinc plated, 2-parts | 0,80 EUR |
| 46 |  | 25361500 | Screw M6x12 mm, hexagonal, AF 10mm, steel, zinc plated, 8.8, mudguard sideways, for Vespa PKXL2/FL/Automatica /50HP/Cosa, horn for Vespa PK50 XL FL/HP /XL2/125 N/XL2/T5 | 0,70 EUR |
| 47 |  | 80008000 | Spring Washer brake arm, M6 mm, Ø 6,1x11,8 mm, (th) 1,6mm, for Vespa PK/S/XL/FL/ HP/N/XL2 /PX Lusso/T5 horn for Vespa PK50-125/T5, spring steel, zinc coated, seat lock for Vespa PK50-125S /Automatica/ETS mudguard sideways | 0,20 EUR |

| | | | | |
|----|---|----------|--|-----------|
| 49 |  | 30560000 | Washer screw seat bracket, M6x12 mm, for Vespa PK50-125S/Automatica /ETS/PX80-200 E Lusso handle bar lever for Vespa PKXL FL/HP/N/ XL2/Automatica, rear light for Vespa PX/T5 (2), mudguard sideway for Vespa PK | 0,90 EUR |
| 51 |  | 14528500 | Bracket emission sticker, for french Crit'air vignette, black, plastic, Ø 70 mm, strap=320x15mm | 19,90 EUR |
| 51 |  | 14528400 | Bracket insurance vignette, for french assurance vignette, Certificat d'assurance, black, plastic, l 70 mm, w 50 mm, strap=320x15mm | 19,90 EUR |
| 97 |  | 40526800 | Catalogue VESPA 50, V5N1T italian/french/english/german, 83 p., l=297mm, w=210mm | 18,90 EUR |
| 97 |  | 610062M0 | Instruction Manual PIAGGIO Vespa 125 Primavera 1968, Italian | 16,90 EUR |
| 97 |  | 610187M | Instruction Manual PIAGGIO Vespa V50 V5A1T Italian | 16,90 EUR |
| 97 |  | 6110069M | Instruction Manual PIAGGIO Vespa ET3 Primavera 1976, Italian | 16,90 EUR |
| 97 |  | 610071M0 | Instruction Manual PIAGGIO Vespa PK 50 XL Italian | 16,90 EUR |
| 97 |  | 98980000 | Hand Book Haynes "Workshop Manual 59-78" SS90/PV/Sprint/Rally, English, 90 p. | 29,00 EUR |
| 97 |  | 98883000 | Hand Book "Vespa Tecnica 3" 1965/1976, Italian, limited edition | 66,00 EUR |
| 97 |  | 610066M0 | Instruction Manual PIAGGIO Vespa 50 - 50 Special - 50 Elestart (2. Series) Italian | 16,90 EUR |
| 97 |  | 620012M | Garage Hand Book PIAGGIO Vespa 50 R/Special/Elestart/90/SS /125 VMA1T/PV/Super/GT/TS /150 Super/Sprint/180 SS/180 -200 Rally Italian, 116 p., black/white incl. exploded views, wiring diagram etc. | 40,00 EUR |
| 97 |  | 98873000 | Hand Book "Vespa Tecnica 3" 1965/1976, German, limited edition | 76,00 EUR |

| | | | | |
|-----|---|----------|---|-----------|
| 97 |  | 97836150 | Hand Book "Das Vespa Schrauberhandbuch" Smallframe Modelle von 1965-1989, German, 128 p., l=275mm, w=213mm, ca. 500 Farbfotos, gebunden, ISBN 978-3-95843-043-3 | 24,99 EUR |
| 97 |  | 97836160 | Hand Book "How to restore Classic Smallframe Vespa Scooters" Smallframe Modelle von 1963 bis 1986, English, 120 p., l=270mm, w=207mm, c. 688 illustrations, hardback, ISBN 978-1-845844-37-0 | 35,00 EUR |
| 97 |  | 610064M0 | Instruction Manual PIAGGIO Vespa 50 - 50 Special (1. Series) Italian | 16,90 EUR |
| 97 |  | 98876000 | Hand Book "Vespa Tecnica 3" 1965/1976, English, limited edition | 76,00 EUR |
| 97 |  | 610046M | Instruction Manual PIAGGIO Vespa SS90 Italian | 18,90 EUR |
| 97 |  | 99412000 | Hand Book Klassische VESPA Motorroller - alle PK, PX, Cosa seit 1970" technics, service, repairs, German, 224 p., 650 colour photos and illustrations, 15th edition | 16,90 EUR |
| 98 |  | 14235000 | Brake Cleaner SIP 500ml, spray | 3,90 EUR |
| 98 |  | 14080000 | Multi-Purpose Grease REPSTAR 400g | 5,50 EUR |
| 98 |  | 14230000 | Brake Cleaner MASTERCARE /REPSTAR 500ml, spray | 3,50 EUR |
| 99A |  | 20842000 | Chuck SIP lower bearing shell upper steering column removal, for Vespa all models also for GILERA/PIAGGIO alle Modelle | 22,00 EUR |
| 99A |  | 16561000 | Puller Tool SIP lower bearing shell of lower steering column, for Vespa all models | 69,00 EUR |
| 99A |  | BU5419 | Steering Head Bearing Wrench BUZZETTI universal for GILERA/PIAGGIO/Vespa all models | 21,50 EUR |

| | | | | |
|-----|--|----------|---|------------|
| 99A |  | 21330000 | Tool SIP mounting upper/lower bearing shell, frame, for Vespa all models also for for GILERA/PIAGGIO 50-300ccm 2T/4T AC/LC 450 mm, 4 parts, not for PI597783 | 42,00 EUR |
| 99A |  | BU5420 | Steering Head Bearing Nut SIP universal, for GILERA/PIAGGIO/Vespa all models Grade A - perfect repair | 32,00 EUR |
| 99A |  | 31121400 | Tool SIP rivet steering lock cover rivet end rounder for Vespa 50 N/L/R/S/Special /SR/SS/90/R/SS/125 PV/ET3/GT /GTR/Super/150 Sprint/Super /160 GS/180 SS/Rally | 12,90 EUR |
| 99A |  | 16029000 | Chuck SIP lower bearing shell lower steering column removal installation, for Vespa all models also for GILERA/PIAGGIO alle Modelle | 27,00 EUR |
| 99A |  | 20004000 | Chuck SIP upper bearing shell of lower head set bearing, removal, for Vespa all models also for GILERA/PIAGGIO alle Modelle | 32,00 EUR |
| 99B |  | 20837529 | Set of Socket Spanners MINI 1/4", chrome-vanadium-steel, 160x8.. ..2x32 mm, plastic case, 23 pieces | 42,00 EUR |
| 99B |  | 90980000 | Tool Kit for PIAGGIO/Vespa all models flat/phillips headed screwdriver, spark pulg key 21/13, incl. bag | 18,90 EUR |
| 99B |  | 20837525 | Set of Socket Spanners JMP 1/4" + 1/2", chrome-vanadium-steel, plastic case, 82 parts | 149,00 EUR |
| 99B |  | CR432547 | Tool Box 25-piece | 19,90 EUR |
| 99B |  | MXMG05L | Gloves Mechanix The Original, black, unisex, size L, 60% nylon, 35% polyurethan, 5% elastane | 29,90 EUR |
| 99B |  | 20837520 | Screw Driver Set JMP slotted: 5mm/6mm/8mm, phillips: PH1/PH2/PH3, 6 parts | 35,00 EUR |
| 99B |  | 20837516 | Torque Key JMP 1/4", 5-25 Nm L=335 mm | 70,00 EUR |
| 99B |  | 61627000 | Socket Wrench "Mini" 1/4", lenght grip: 50mm | 35,00 EUR |
| 99B |  | 12194000 | Knee Pad SIP 435x195x30 mm, foam EVA, black /red | 10,20 EUR |

| | | | | |
|-----|---|----------|--|-----------|
| 99B |  | 20837515 | Torque Key JMP 3/8", 20-110 Nm L=403 mm | 70,00 EUR |
| 99B |  | 20837522 | Combination Wrench Set JMP chrome-vanadium-steel, 6,7,8.. ,9,10,11,12,13,14,17,19,22 mm, 12-parts | 57,00 EUR |
| 99B |  | 90982000 | Tool Kit wrench 7/8 8/11 regular, phillips screwdriver, spark plug wrench 21/13 | 15,00 EUR |
| 99B |  | 90970410 | Tool Bag SIP Classic, 640 mm, 270 cm, nylon, black, empty, w/o tools for a first-class repair - grade AA | 29,00 EUR |
| 99B |  | 20837521 | Open-End Wrench Set JMP chrome-vanadium-steel, 6/7, 8 ,9, 10/11, 12/13, 14/15, 16 /17, 18/19, 20/22 mm, 8-parts | 35,00 EUR |
| 99B |  | 20837519 | Set of Socket Spanners JMP 1/2", chrome-vanadium-steel, plastic case, 29 parts | 99,00 EUR |
| 99B |  | 20837517 | Allen Wrench Set JMP 1,5/2/2,5/3/4/5/6/8/10 mm, with ball end, 9 parts | 27,00 EUR |
| 99B |  | 20837518 | Set of Socket Spanners JMP 1/4", chrome-vanadium-steel, plastic case, 46 parts | 85,00 EUR |
| 99B |  | 20837523 | Pliers Set KNIPEX universal pliers/wire cutter /water pump pliers, 3 parts | 75,00 EUR |
| 99B |  | 12194100 | Floor Mat SIP 3 in 1 1210x420x30 mm, foam EVA, black/red, knee pad, cushion and floor mat all in one | 24,90 EUR |