

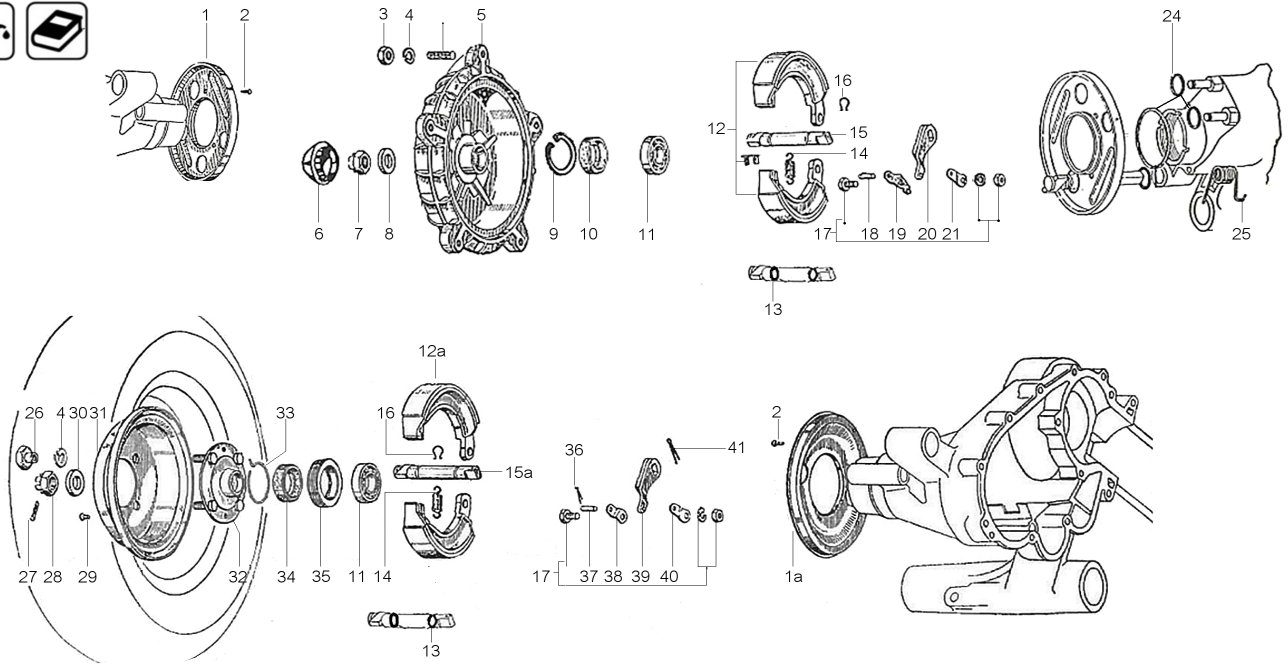







E809 Brake Drum rear





		Prod.no.	Product name	Gross Price
1		78485000	Dust Cover rear wheel, for Vespa 125 GT/GTR/TS/150 GL 2° /Sprint/V/180-200 Rally/PX80 -200/PE/Lusso/'98/MY/'11/T5 chrome	11,90 EUR
1		78482000	Dust Cover rear wheel, for Vespa PX/T5/GT/GTR/TS/Rally /Sprint Grade B - decent repair	9,90 EUR
1		78482100	Dust Cover PIAGGIO rear wheel, for Vespa PX/T5/GT/GTR/TS /Rally/Sprint Grade A - for a true to original repair	14,90 EUR
1a		78483000	Dust Cover for rear wheel 8", for Vespa VBA/VBB/VNA/VNB /P150S/VNC/VBC 2-bolt seating, brake shoes	8,70 EUR
2		12166800	Sheet Metal Screw dust cap rear wheel, for Vespa/LML PX/T5/LML Star 125-200 2T/4T/ Star Deluxe /II 125 Automatica/CVT, rear wheel spoiler for Vespa T5, speedometer cover (top) for Vespa PK XL2/FL lock glove box for Vespa PK/S	0,60 EUR
3		87191000	Nut M8 mm, steel, zinc plated, AF 11mm, h 6,4mm, rim Vespa	0,60 EUR
3		87303000	Nut M8 mm, Pikenut, chromed, SIP, as a very nice accessory	2,90 EUR
3		87180000	Nut M8 mm, 8, steel, zinc plated, AF 13mm, h 6,5mm	0,20 EUR





3		87185000	Nut Kit M8 mm, 8, steel, zinc plated, AF 13mm, h 6,5mm, 50 pcs	8,50 EUR
3		87301000	Nut M8 mm, Acorn, chromed	2,70 EUR
3		50412400	Nut M8 mm, LML, for LML Star 200 4T	0,90 EUR
4		80108000	Locking Washer NORD-LOCK M8 mm, Ø 13,5x8,7 mm, (th) 2,5mm, Type NL8, zinc plated, 2-parts	0,80 EUR
4		80012000	Shim M8 mm, Ø 8,4x15 mm, (th) 0,8mm, spring steel, zinc coated	0,20 EUR
4		80002000	Washer M8 mm, Ø 8,4x16 mm, (th) 1,6mm, steel, zinc plated, 140 HV	0,20 EUR
4		80005000	Spring Washer M8 mm, Ø 8,1x1..4,8 mm, (th) 2mm, spring steel, zinc coated	0,20 EUR
5		79766710	Brake Drum FA rear, for Vespa 125/150 Super/P150S for open 8" rim, Ø inside 135mm	62,00 EUR
5		19443330	Brake Drum FA rear, for Vespa 125 GT/GTR/TS/150 Sprint/V /Rally/P80-150X/PX80-200E for open 10" rim, Ø inside 150mm, oil seal seat 27mm Grade A - perfect repair	55,00 EUR
5		19443320	Brake Drum PIAGGIO rear, for Vespa 125 GT/GTR/TS/150 Sprint /V/Rally/P80-150X/PX80-200E for open 10" rim, Ø inside 150mm, oil seal seat 27mm Grade D - adequate repair	65,00 EUR
5		19443310	Brake Drum rear, for Vespa 125 GT/GTR/TS/150 Sprint/V /Rally/P80-150X/PX80-200E ECO quality, chrome, for open 10" rim, Ø inside 150mm, oil seal seat 27mm as accessory	49,00 EUR
5		79766700	Brake Drum PIAGGIO rear, for Vespa 125/150 Super/P150S for open 8" rim, Ø inside 135mm	89,00 EUR
5		19443300	Brake Drum RMS rear, for Vespa 125 GT/GTR/TS/150 Sprint/V /Rally/P80-150X/PX80-200E for open 10" rim, Ø inside 150mm, oil seal seat 27mm Grade C - low-priced repairs	55,00 EUR

6		87220000	Hub Nut Cover brake drum, front & rear, for Vespa 50 Special V5B1-4T/SS/90 R/SS /100 2°/125/PV/ET3/125 GT /GTR/TS/150 GL/GS VS5T /Sprint/V/160 GS/180 SS /Rally/P200E 2°/PX80-150 E 2°/Lusso/'98/MY/'11/T5 rear for Vespa 125 VGLA/B/P80 -150X/P200E 1°/PX80-150 E 1° Ø 36 mm, metal, chrome, Grade A - perfect repair	3,90 EUR
6		PI000523	Hub Nut Cover brake drum, for front&rear, for Vespa Primavera/Sprint 50-150ccm rear for Vespa 50 Special V5B1 -4T/SS/90 R/SS/100 2°/125/PV /ET3/125 GT/GTR/TS/150 GL/GS VS5T/Sprint/V/160 GS/180 SS /Rally/P200E 2°/PX80-150 E 2°/Lusso/'98/MY/'11/T5 Ø 36 mm, stainless steel polished	6,10 EUR
6		87223000	Hub Nut Cover brake drum, front & rear, for Vespa 125 -150 Super/P150S Ø 40 mm, stainless steel polished	6,60 EUR
6		87227000	Hub Nut Cover brake drum, front & rear, for Vespa 50 Special V5B1-4T/SS/90 R/SS /100 2°/125/PV/ET3/125 GT /GTR/TS/150 GL/GS VS5T /Sprint/V/160 GS/180 SS /Rally/P200E 2°/PX80-150 E 2°/Lusso/'98/MY/'11/T5 rear for Vespa 125 VGLA/B/P80 -150X/P200E 1°/PX80-150 E 1° Ø 35 mm, plastic, black, Grade B - decent repair	4,90 EUR
7		23140000	Castle Nut M14x1,5 mm, black, AF 22mm, SIP, brake drum, rear, 50-125/PV/ET3/125 VN-TS/150 VL -Super/160 GS/180 SS/Rally /P80-150X/PX80-150 E 1° /P150S 1°/P200E 1°, front 50 R 2°-125/PV/ET3/PK50 /S/SS/XL/XL2/125 Super 2°/TS /150 GL/VGLA/B/Sprint/V /Super 2°/160 GS/180 SS /Rally/P150S, Grade A - perfect repair	2,40 EUR
7/28		87200000	Nut M16 mm, AF 24mm, h 13,0mm, RMS, brake drum, rear, for Vespa 50 S 3°/Special V5B3T 2°/90 3°/100 2°/125 PV 2°/ET3 2°/PK50/S/SS/XL/2/FL /HP/N/Rush/PK80-125S/PK125 /ETS/N/XL/XL2//PX80-150 E 2° /P150S 2°/P200E 2°/PX80-200 E Lusso/'98/MY/'11/T5/Cosa, for GILERA/PIAGGIO 50-180ccm	2,40 EUR

8		13879000	Spacer brake drum, rear, for Vespa 125 Super/150 GS/Super /160 GS/180 SS/P150S 1° front for Vespa 50 N (D) /Special/SR (D)/SS/90/R/SS /125/PV/ET3/125 TS 1°/VGLA/B /150 GL/GS VS5T/Sprint/V 1° /160 GS/180 SS/Rally h 2,0 mm, Ø 25,0mm, Øi 14,0 mm	1,70 EUR
8		15934700	Spacer brake drum, rear, for Vespa PX80-150 E 2°/P150S 2° /P200E 2°/PX80-200 E Lusso /'98/MY/'11/T5/Cosa also for LML Star 125-200 2T /4T/ Star 125/II/Lite 4T Automatica/CVT h 1,5 mm, Ø 32,0mm, Øi 16,5 mm	1,40 EUR
8		18398000	Spacer brake drum, rear, for Vespa 50 S 3°/Special V5B3T 2° /90 3°/100 2°/125 PV 2°/ET3 2°/PK50/S/SS/XL/2/FL/HP/N /Rush/PK80-125S/PK125/ETS/N /XL/XL2 h 7,0 mm, Ø 31,5mm, Øi 16,5 mm	4,00 EUR
8		15005100	Spacer brake drum, rear, for Vespa 50 2°/L/R 1°/S 2° /Special V5B2/3 1°/4T/SR/SS /90 2°/100 1°/125/PV 1°/ET3 1° h 8,5 mm, Ø 31,5mm, Øi 14,5 mm, steel, bronzed, Grade A - perfect repair	3,90 EUR
8		15930000	Spacer brake drum, rear, for Vespa 50 1°/R 2°/S 1°/Special V5A2/3T/90 1°/ 125 VM/VN/VNA /VNB/GT/GTR/TS/150 VL/VB1 /VBA/VBB/VD/VGLA/B/1/GL /Sprint/V/Rally/P80-150X /PX80-150 E 1°/P150S 1° /P200E 1° h 4,0 mm, Ø 27,0mm, Øi 14 mm	1,40 EUR
9		66470000	Cluster Circlip bearing driveshaft, for Vespa 125 GT 2°/GTR 2°/TS/150 Sprint 2°/V 2°/Super 2°/200 Rally/P80-200 /PE/Lusso/T5/Cosa/GILERA /PIAGGIO Scooter bearing clutch for Vespa 50 -125/PV/ET3/PK/XL/XL2 input shaft/primary V50/PV/ET3 /PK/S	1,70 EUR
10		91031000	Oil Seal driveshaft for Vespa 125 GT 2°/GTR 2°/TS /150 Sprint 2°/V 2°/200 Rally/P80-150X/P200 E 1° /PX80-200E 1°, CORTECO, 27x47x6 mm, blue	5,80 EUR
10		91030000	Oil Seal driveshaft for Vespa 125 GT 2°/GTR 2°/TS /150 Sprint 2°/V 2°/200 Rally/P80-150X/P200 E 1° /PX80-200E 1°, KOK, 27x47x6 mm, black	4,10 EUR

11		90032000	Bearing driveshaft wheel side for Vespa 50-125/PV/ET3/PK/XL /XL2/125 VNA-TS/150 VBA -Super/Rally/PX80-200/PE /Lusso 1°, inner for Vespa 125 VN2T 2° /150 VL3T/VB1/VGL1/GS/T1-T3 SKF, CN, 20x47x14 mm	9,70 EUR
11		90030000	Bearing Crankshaft flywheel side for Vespa 50 2°/N/L/R/S 2° /Special/SR/SS/PK50/S/SS/XL /XL2/Ape 50, drive shaft wheelside for Vespa 50-125/PV/ET3/PK/XL/XL2 /125 VNA-TS/150 VBA-Super /Rally/PX80-200/PE/Lusso 1° crankshaft for MINARELLI SKF, C3, 20x47x14 mm	9,50 EUR
11		21104120	Castle Nut h 13,1mm, Ø 49mm, Øi 40 mm, 9 slots bearing driveshaft, for Vespa 125 Super/150 Super VBC -> 153261, front wheel bearing for Vespa 160 GS/180 SS	9,90 EUR
11		M6611566B	Bearing crankshaft flywheel side for Vespa 50 2°/N/L/R/S 2° /Special/SR/SS/PK50/S/SS/XL /XL2/Ape 50, drive shaft wheelside for Vespa 50-125/PV/ET3/PK/XL/XL2 /125 VNA-TS/150 VBA-Super /Rally/PX80-200/PE/Lusso 1° MALOSSİ MHR, C3H, with polyamide cage, 20x47x14 mm, Ø ball: 9,525mm	11,90 EUR
11		6204C4	Bearing Crankshaft for MINARELLI 50cc drive shaft wheelside for GILERA/PIAGGIO 50-180ccm for Vespa 50-125/PV/ET3/PK/XL /XL2/125 VNA-TS/150 VBA -Super/Rally/PX80-200/PE /Lusso 1° SKF, C4, 20x47x14 mm	10,90 EUR
11		43473500	Bearing driveshaft wheel side for Vespa PX80-200 E Lusso 2° /'98/MY/'11/T5/Cosa, for PIAGGIO Hexagon/SKR/TPH for LML Star 125-150 2T/4T /Star 125 Deluxe/II Automatica/CVT SKF, C4, 20x47x14 mm, capsuled	11,50 EUR
11		43473600	Bearing driveshaft wheel side for Vespa PX80-200 E Lusso 2° /'98/MY/'11/T5/Cosa, for PIAGGIO Hexagon/SKR/TPH for LML Star 125-150 2T/4T /Star 125 Deluxe/II Automatica/CVT SKF, CN, 20x47x14 mm, capsuled	11,00 EUR









11		M6616065B	Bearing crankshaft flywheel side for Vespa 50 2°/N/L/R/S 2° /Special/SR/SS/PK50/S/SS/XL /XL2/Ape 50, drive shaft wheelside for Vespa 50-125/PV/ET3/PK/XL/XL2 /125 VNA-TS/150 VBA-Super /Rally/PX80-200/PE/Lusso 1° MALOSSİ MHR, C4, with polyamide cage, 20x47x14 mm, Ø ball: 7,938mm	15,90 EUR
12		87330200	Brake Shoes SIP PREMIUM 10", front & rear, for Vespa PK50 -125/S/XL/XL2/PK50 XL FL/HP /N/Rush/PX/T5 rear for Vespa 125 GT-TS/150 GS VS5T-Sprint V/160 GS/180 SS/Rally/LML Star 125-150 2T /4T /Star 125 Deluxe/II Automatica/CVT w 25 mm, 2 seatings, for brake drum Ø interior 150mm ROAD-TUNING, for everyday use & reliable Grade AA - first -class repair	12,90 EUR
12		87333000	Brake Shoes PIAGGIO 10", front & rear, for Vespa PK50-125/S /XL/XL2/PK50 XL FL/HP/N/Rush /PX/T5 rear for Vespa 125 GT-TS/150 GS VS5T-Sprint V/160 GS/180 SS/Rally/LML Star 125-150 2T /4T /Star 125 Deluxe/II Automatica/CVT w 25 mm, 2 seatings, for brake drum Ø interior 150mm	16,90 EUR
12		87335000	Brake Shoes NEWFREN 10", front & rear, "AntiAQUA" for Vespa PK50-125/S/XL/XL2/PK50 XL FL /HP/N/Rush/PX/T5 rear for Vespa 125 GT-TS/150 GS VS5T-Sprint V/160 GS/180 SS/Rally/LML Star 125-150 2T /4T /Star 125 Deluxe/II Automatica/CVT w 24 mm, 2 seatings, for brake drum Ø interior 150mm Grade A - perfect repair	12,20 EUR
12		87330100	Brake Shoes SIP PERFORMANCE 10", front & rear, for Vespa PK50-125/S/XL/XL2/PK50 XL FL /HP/N/Rush/PX/T5 rear for Vespa 125 GT-TS/150 GS VS5T-Sprint V/160 GS/180 SS/Rally/LML Star 125-150 2T /4T /Star 125 Deluxe/II Automatica/CVT w 25 mm, 2 seatings, for brake drum Ø interior 150mm SPORT-TUNING, high-performance & roadworthy Grade AA - first -class repair	16,90 EUR







12		87330000	Brake Shoes FA 10", front & rear, for Vespa PK50-125/S/XL /XL2/PK50 XL FL/HP/N/Rush/PX /T5 rear for Vespa 125 GT-TS/150 GS VS5T-Sprint V/160 GS/180 SS/Rally/LML Star 125-150 2T /4T /Star 125 Deluxe/II Automatica/CVT w 25 mm, 2 seatings, for brake drum Ø interior 150mm Grade B - decent repair	8,20 EUR
12		17601280	Brake Shoes POLINI 10", front & rear, for Vespa PK50-125/S /XL/XL2/PK50 XL FL/HP/N/Rush /PX/T5 rear for Vespa 125 GT-TS/150 GS VS5T-Sprint V/160 GS/180 SS/Rally/LML Star 125-150 2T /4T /Star 125 Deluxe/II Automatica/CVT w 25 mm, 2 seatings, for brake drum Ø interior 150mm ROAD-TUNING, for everyday use & reliable Grade A - perfect repair	16,90 EUR
12a		87570100	Brake Shoes SIP PERFORMANCE 8", rear, for Vespa 125 V1-33/VM /VN/VNA/VNB1-3T/150 VL/VB /VBA/VBB1T/VGL1 w 23 mm, 1 seating, for brake drum Ø interior 127mm SPORT-TUNING, high-performance & roadworthy Grade AA - first -class repair	24,90 EUR
12a		87576100	Brake Shoes PINASCO front, for Vespa 125 V1-33/VM/VN/VNA /VNB1-3T/150 VL/VB/VBA/VBB1T /VGL1 1 seating, for brake drum PINASCO Highbrake SPORT-TUNING, high-performance & roadworthy Grade AA - first -class repair	25,00 EUR
12a		87571000	Brake Shoes NEWFREN 8", rear, "AntiAQUA" for Vespa 125 V1-33 /M/VN/VNA/VNB1-3/150 VL/VB /VBA/VBB1/VGL1 w 23 mm, 1 seating, for brake drum Ø interior 127mm Grade A - perfect repair	22,50 EUR
12a		87610000	Brake Shoes FA 8", rear, for Vespa 125/150 Super/P150S w 28 mm, 2 seatings, for brake drum Ø interior 135mm Grade B - decent repair	22,40 EUR
12a		87611000	Brake Shoes NEWFREN 8", rear, "AntiAQUA" for Vespa 125/150 Super/P150S w 28 mm, 2 seatings, for brake drum Ø interior 135mm Grade A - perfect repair	28,00 EUR









12a		87610100	Brake Shoes SIP PERFORMANCE 8", rear, for Vespa 125/150 Super /P150S w 28 mm, 2 seatings, for brake drum Ø interior 135mm SPORT-TUNING, high-performance & roadworthy Grade AA - first class repair	24,90 EUR
12a		87580000	Brake Shoes NEWFREN 8", rear, for Vespa 125-150 VNB4-6T /VBB2T w 23 mm, 2 seatings, for brake drum Ø interior 127mm Grade A - perfect repair	17,90 EUR
12a		87570000	Brake Shoes NEWFREN 8", rear, for Vespa 125 V1-33/VM/VN/VNA /VNB1-3T/150 VL/VB/VBA/VBB1T /VGL1 w 23 mm, 1 seating, for brake drum Ø interior 127mm Grade A - perfect repair	20,50 EUR
12a		87580100	Brake Shoes SIP PERFORMANCE 8", rear, for Vespa 125-150 VNB4 -6T/VBB2T w 23 mm, 2 seatings, for brake drum Ø interior 127mm SPORT-TUNING, high-performance & roadworthy Grade AA - first class repair	24,90 EUR
13		97497000	O-Ring brake cam, 17,5mm, Øi 12,5 mm, (th) 2,4mm, for Vespa 50-125/PV/ET3/PK50 -125/S/XL/XL2 spring seating, spring steering column for Vespa 150 VL/VB/VBA/VBB/Sprint 2° /VSuper/Rally,2	1,45 EUR
13		67140000	O-Ring axle brake cam, Ø 15x.. ..12x2 mm, for Vespa PX/Lusso/T5/VNA-T4 /Rally 180-200/PK	1,00 EUR
14		16115000	Spring brake shoes, rear, for Vespa V50/PV/ET3/ VNA-T4 /Rally 180 front/rear for Vespa PX/T5/PK /S/XL/XL2/FL	2,20 EUR
15		97182000	Brake Cam rear, for Vespa 125 GT/GTR/Super/TS/150 Sprint /V/Super/Rally/PX80-200/PE /Lusso/T5 with lever and cable mounting	25,70 EUR
15		51315780	Brake Cam LML rear, for LML Star 125-150 4T/Star Deluxe 125-150 4S/Speedy also for Vespa 125 GT/GTR /Super/TS/150 Sprint/V/Super /Rally/PX80-200/PE/Lusso/T5 Grade C - low-priced repairs	17,90 EUR









15a		97181000	Brake Cam P/A rear, for Vespa 125 GT/GTR/Super/TS/150 Sprint /V/Super/Rally/PX80-200/PE /Lusso/T5 also for LML Star 125-150 4T /Star Deluxe 125-150 4S /Speedy incl. O-rings Grade AA - for a first-class repair	23,90 EUR
16		87390000	Securing Clip brake shoes, for Vespa V50/PV/ET3/VNA-T4 /Rally 180-200/ GS-3/PK/S/XL /XL2/FL/PX/Lusso/T5 also for LML Star 125-200 2T /4T/ Star 125/II/Lite 4T Automatica/CVT	1,20 EUR
17		17726000	Cable Nipple M9 mm, brake cable rear, for Vespa V50/PV/ ET3/PK/S/XL /XL2/FL/ PX/Rally/Sprint	3,40 EUR
17/19		17726100	Cable Nipple OLYMPIA brake cable rear, for Vespa V50/PV/ET3/PK/S/XL /XL2/FL/PX- Rally, incl. plates	6,00 EUR
19		94779000	Dies brake arm, rear, for Vespa V50/PV/ET3/ /PK/S/XL/XL2 /FL/PX/Rally/Sprint large, with hook	2,00 EUR
20/39		10010140	Brake Lever PIAGGIO rear, for Vespa P80/P80-150X/PX 80 -150E/Lusso/'98/MY/P150S VNL /TS/VBA/VBB/VLA/VLB/VNC/VBC Rally 180 also for LML Star 125-150 4T /Star Deluxe 125-150 4S /Speedy Grade A - perfect repair	9,10 EUR
21		42047000	Dies brake arm, rear, for Vespa V50/PV/ET3/ /PK/S/XL/XL2 /FL/PX/Rally/Sprint large, w/o hook	1,90 EUR
24		78168000	O-Ring dust cap rear wheel (large), rear, for Vespa PX/T5/GT/GTR/TS /Sprint/Rally	1,90 EUR
24		13943300	O-Ring Kit dust cap rear wheel (small), for Vespa PX/T5/GT/GTR/Sprint/ Rally 3 pcs	3,30 EUR
24		13943400	O-Ring Kit engine, for Vespa 125 GT-TS/150 GL -Super/Rally/PX80-200/PE /Lusso/T5 8-parts	6,80 EUR
25		47750000	Spring brake arm, rear, for Vespa PX/T5/Rally/GT/ GTR/TS /Sprint/Super also for LML Star 125-200 4T /Star Deluxe 125-150 4S /Speedy Grade AA - for a first-class repair	4,00 EUR















26		87430000	Nut M8 mm, zinc plated, AF 22mm, for 8" rim, closed, for Vespa 125 VN/VNA/VNB1-2T /150 VL/VB1/VBA/VBB1T -> 71000/GS VS1-4T, h: shaft: 8mm/ collar: 7mm/ total: 15mm	3,20 EUR
27		87240000	Cotter Pin brake drum, rear, for Vespa 50-125/PV/ET3/PK/XL /XL2/125 VN-TS/150 VL-Super /160 GS/180 SS/Rally/PX80 -200/PE/Lusso/T5/Cosa front for Vespa 50 R 2°-125/PV /ET3/PK50/S/SS/XL/XL2/125 Super 2°/TS/150 GL/VGLA/B /Sprint/V/Super 2°/160 GS /180 SS/Rally/P150S 3,2x50 mm, steel, zinc plated	0,60 EUR
29		23208900	Screw M4x8 mm, counter sunk, steel, zinc plated, 8.8, brake drum seatin 8" 10" closed, for Vespa 125/150/VNA/VBA/VNB /VBB/GS150/T2/T3, Kit 2 pcs	2,90 EUR
31		83011000	Spacer SIP rim, for Vespa 98/125 V1-15/V30-33/VU/VM/VN /VNA/Hoffmann/VNB/ACMA/150 VL/VB/VBA/VBB h 5 mm, Ø 110 mm, aluminium CNC, 4-hole, RACE chassis - first-class	22,90 EUR
31		23208250	Brake Drum FA rear, for Vespa 125 V1-33T/VM/VN/VNA/VNB/150 VL/VB1/VBA/VBB premium quality, for closed 8" rim, Ø inside 127mm	65,00 EUR
31		23208200	Brake Drum BAJAJ rear, for Vespa 125 V1-33T/VM/VN/VNA/VNB /150 VL/VB1/VBA/VBB ECO quality, for closed 8" rim, Ø inside 127mm Grade C - low-priced repairs	49,00 EUR
31		23208261	Brake Drum SIP PERFORMANCE rear, VBB Style for Vespa 125 V1-15/V30-33/VU/VM/VN/VNA /Hoffmann/VNB/ACMA/150 VL/VB /VBA/VBB steel, nitrided, CNC machined, for closed 8" rim, Ø inside 127mm Grade AA - for a first-class repair for tuned engines	89,00 EUR
31		23208260	Brake Drum SIP PERFORMANCE rear, "Sei Giorni Style" for Vespa 125 V1-15/V30-33/VU/VM /VN/VNA/Hoffmann/VNB/ACMA /150 VL/VB/VBA/VBB steel, nitrided, CNC machined, for closed 8" rim, Ø inside 127mm Grade AA - for a first-class repair for tuned engines	89,00 EUR







32		23208390	Drum Brake Seating rear, for Vespa 125 VNA/VNB1-2/150 VBA/VBB ->71000, M8, 4-hole, gearing: raw, Grade B - decent repair	39,00 EUR
32	No Picture	23208381	Drum Brake Seating rear, for Vespa 125 VNB3-6T/150 VBB1T 71001->VBB2T, also for Vespa 125 VNA/VNB1-2 /150 VBA/VBB -> 71000 M10, 4-hole, gearing: raw, Grade B - decent repair	39,00 EUR
32		23208380	Drum Brake Seating rear, for Vespa 125 VNB3-6T/150 VBB1T 71001->VBB2T, also for Vespa 125 VNA/VNB1-2 /150 VBA/VBB -> 71000 M10, 4-hole, gearing: raw, Grade C - low-priced repairs	29,00 EUR
33		19739000	Cluster Circlip castle nut, bearing driveshaft, for Vespa 125 VNA/VNB/GT 1°/GTR 1°/150 VBA/VBB/VGLA/B/GL/Sprint 1° /V 1°/180 Rally	1,90 EUR
34		M6617438	Oil Seal driveshaft for Vespa 50-125/PV/ET3/PK/XL /XL2/125 VNA/VNB/GT 1°/GTR 1°/150 VBA/VBB/VGLA/B/GL /Sprint 1°/V 1°/180 Rally, MALOSSSI, FKM/PTFE, 27x37x7 mm, black	12,00 EUR
34		46599000	Oil Seal driveshaft for Vespa 50-125/PV/ET3/PK/XL /XL2/125 VNA/VNB/GT 1°/GTR 1°/150 VBA/VBB/VGLA/B/GL /Sprint 1°/V 1°/180 Rally, KOK, 27x37x7 mm, black	4,00 EUR
34		46598000	Oil Seal driveshaft for Vespa 50-125/PV/ET3/PK/XL /XL2/125 VNA/VNB/GT 1°/GTR 1°/150 VBA/VBB/VGLA/B/GL /Sprint 1°/V 1°/180 Rally, CORTECO, 27x37x7 mm, blue	4,90 EUR
35		21104150	Castle Nut h 12,0mm, Ø 49mm, Øi 37 mm, 8 slots bearing driveshaft, for Vespa 125 VNA/VNB/GT 1° /GTR 1°/150 VBA/VBB/VGLA/B /GL/Sprint 1°/V 1°/180 Rally	11,50 EUR
35		21104170	Castle Nut h 12,0mm, Ø 49mm, Øi 40 mm, 8 slots conversion to 30mm PX brake drum, driveshaft, for Vespa 125 VNA/VNB/GT 1° /GTR 1°/150 VBA/VBB/VGLA/B /GL/Sprint 1°/V 1°/180 Rally, incl. oil seal 30x40x7mm	16,90 EUR

36		12761000	Cotter Pin pin brake lever, rear, for Vespa V50/PV/ET3/ PK /S/XL/XL2/FL/PX/V1-33/ VM -VB1/VNA-T4/160GS/180SS/ Rally for LML Star 125-200 2T/4T /Deluxe 2T/4S/Speedy/Stella 1x10 mm, steel, zinc plated	0,60 EUR
37/18		51415870	Pin 5,5x13 mm, LML brake arm, rear, for LML Star 125-200 4T/Star Deluxe 125-150 4S/Speedy, brake arm rear for Vespa 50 -125/PV/ET3/PK/S/XL/XL2/125 GT-TS/150 GL/GS VS5T/Sprint /V/T4/160 GS/180 SS/Rally/PX /PE/Lusso/LML Star/DLX /Deluxe 2T, Grade A - perfect repair	1,90 EUR
37/18		90306100	Pin 5,5x13 mm, PIAGGIO brake arm rear, for Vespa 50-125/PV/ET3/PK/S /XL/XL2/125 GT-TS/150 GL/GS VS5T/Sprint/V/T4/160 GS/180 SS/Rally/PX/PE/Lusso/LML Star/DLX/Deluxe 2T/4T, Grade A - perfect repair	3,90 EUR
37/18		90306000	Pin 5,5x13 mm, brake arm rear, for Vespa 50-125/PV/ET3/PK/S /XL/XL2/125 GT-TS/150 GL/GS VS5T/Sprint/V/T4/160 GS/180 SS/Rally/PX/PE/Lusso/LML Star/DLX/Deluxe 2T/4T, Grade B - decent repair	1,90 EUR
38/40		17726200	Cable Nipple brake cable rear, for Vespa 125 VNA-TS/150 VBA -T4/160 GS/180 SS/Rally premium quality, incl. plates/bolt/split pin	6,00 EUR
39		J50015200	Conversion Kit Brake Cable Rear Vespa T5 for Vespa 125 VNA-TS/150 VBA-Sprint/Rally w/o sleeve, grey, steel, zinc plated Grade A - perfect repair	29,00 EUR
41		32080000	Cotter Pin brake arm, rear, for Vespa 125 VNA-TS/150 VBB -Super/Rally/PX80-200/PE brake lever front for Vespa 125 GT/GTS/TS/150 GS/VGLA/B/GL /Sprint/V/180-200 Rally 2x25 mm, steel, zinc plated	0,60 EUR
97		97836140	Hand Book "Jetzt helfe ich mir selbst" Vespa Restaurierung - Vespa-Oldtimer wieder flott gemacht German, 160 p., w=200mm, h 265,0mm, hardback	29,90 EUR
97		610059M0	Instruction Manual PIAGGIO Vespa 125 1965 Italian	16,90 EUR
97		610058M0	Instruction Manual PIAGGIO Vespa 125 - 150 Super 1965 Italian	16,90 EUR

97		610054M0	Instruction Manual PIAGGIO Vespa 150 1959 Italian	16,90 EUR
97		98882000	Hand Book "Vespa Tecnica 2" 1956/1964 Italian, limited edition	66,00 EUR
97		610061M0	Instruction Manual PIAGGIO Vespa 150 Sprint - GT 1965-66 Italian	16,90 EUR
97		6110068M	Instruction Manual PIAGGIO Vespa 150 Sprint Veloce - 125 TS 1975 (2. Series) Italian	16,90 EUR
97		610055M0	Instruction Manual PIAGGIO Vespa 150 1961 Italian	16,90 EUR
97		610068M0	Instruction Manual PIAGGIO Vespa 150 VBB2T 1963 Italian	16,90 EUR
97		610057M0	Instruction Manual PIAGGIO Vespa 125 1964 Italian	16,90 EUR
97		98980000	Hand Book Haynes "Workshop Manual 59-78" SS90/PV/Sprint /Rally English, 90 p.	29,00 EUR
97		610185M	Instruction Manual PIAGGIO Vespa 150 VBB1T Italian	27,00 EUR
97		610053M0	Instruction Manual PIAGGIO Vespa 125 1958 Italian	16,90 EUR
97		610184M	Instruction Manual PIAGGIO Vespa 150 GL, VLA1T Italian	25,00 EUR
97		610067M0	Instruction Manual PIAGGIO Vespa 200 Rally 1972 Italian	16,90 EUR
97		610045M	Instruction Manual PIAGGIO Vespa GS150 1958-61 Italian	29,00 EUR
97		610044M	Instruction Manual PIAGGIO Vespa 150 1957 Italian	16,90 EUR
97		610056M0	Instruction Manual PIAGGIO Vespa 125 1962 Italian	16,90 EUR
97		610182M	Instruction Manual PIAGGIO Vespa 125 VNB 1963 Italian	27,00 EUR
97		620012M	Garage Hand Book PIAGGIO Vespa 50 R/Special/Elstart/90/SS /125 VMA1T/PV/Super/GT/TS /150 Super/Sprint/180 SS/180 -200 Rally Italian, 116 p., black/white incl. exploded views, wiring diagram etc.	40,00 EUR
97		98873000	Hand Book "Vespa Tecnica 3" 1965/1976 German, limited edition	76,00 EUR

97		610063M0	Instruction Manual PIAGGIO Vespa 180 Rally 1968 Italian	16,90 EUR
97		610043M	Instruction Manual PIAGGIO Vespa GS150 1956/57/58 Italian	22,00 EUR
97		98876000	Hand Book "Vespa Tecnica 3" 1965/1976 English, limited edition	77,00 EUR
97		98872000	Hand Book "Vespa Tecnica 2" 1956/1964 German, limited edition	76,00 EUR
97		610183M	Instruction Manual PIAGGIO Vespa 125 VNA Italian, l=168mm, w=120mm, h 2,5mm	27,00 EUR
97		97836170	Hand Book "How to restore Classic Largeframe Vespa Scooters" disc valve, 2-stroke, 1959 - 2008 English, c. 878 illustrations, hardback, ISBN 978-1-845843-24-3	39,00 EUR
97		620011M	Garage Hand Book PIAGGIO VESPA all models since 1955 Italian, 112 p., black/white incl. exploded views, wiring diagram etc.	40,00 EUR
98		14235000	Brake Cleaner SIP 500ml, spray	4,50 EUR
98		14080000	Multi-Purpose Grease REPSTAR 400g	5,50 EUR
98		14100000	Thread Locker LOCTITE "243", medium strength, blue, 5ml	10,90 EUR
98		14230000	Brake Cleaner MASTERCARE /REPSTAR 500ml, spray	3,50 EUR
99A		15199007	Drum Brake Holder HESOTEC for Vespa 125 GT/GTR/TS/150 Sprint/V/Rally/PX80-200/PE /Lusso/'98/MY/'11/T5/Cosa	45,00 EUR
99A		15193200	Hook & Pick Set oil ring removal, incl. mini magnet	9,90 EUR
99A		14356000	Tool SIP stud unscrew tool Set M6x1.0 mm/M7x1.0 mm/M8x1.25 mm	18,90 EUR
99A		10550000	Engine Mounting Support CUPP..INI for Vespa 125 VNA-TS/150 VBA -T4/160 GS/180 SS/Rally/PX80 -200/PE/Lusso/'98/MY/'11/T5 /Cosa chrome	35,00 EUR

99A		25276600	Castle Nut SIP for castle nut bearing drive shaft for Vespa 125 VNA/VNB/GT 1° /GTR 1°/150 VBA/VBB/VGLA/B /GL/Sprint 1°/V 1°/180 Rally also for front wheel bearing castle nut for Vespa 160 GS /180 SS Ø 46,9 mm, 8/9 pins, 2.8mm	29,00 EUR
99A		14356800	Tool SIP stud unscrew tool M8x1.25 mm	6,90 EUR
99B		20837529	Set of Socket Spanners MINI 1/4", chrome-vanadium-steel, 160x8.. ..2x32 mm, plastic case, 23 pieces	42,00 EUR
99B		90980000	Tool Kit for PIAGGIO/Vespa all models flat/phillips headed screwdriver, spark pulg key 21/13, incl. bag	19,50 EUR
99B		20837525	Set of Socket Spanners JMP 1/4" + 1/2", chrome-vanadium-steel, plastic case, 82 parts	149,00 EUR
99B		CR432547	Tool Box 25-piece	19,90 EUR
99B		MXMG05L	Gloves Mechanix The Original, black, unisex, size L, 60% nylon, 35% polyurethan, 5% elastane	29,90 EUR
99B		20837520	Screw Driver Set JMP slotted: 5mm/6mm/8mm, phillips: PH1/PH2/PH3, 6 parts	35,00 EUR
99B		20837516	Torque Key JMP 1/4", 5-25 Nm L=335 mm	70,00 EUR
99B		61627000	Socket Wrench "Mini" 1/4", lenght grip: 50mm	35,00 EUR
99B		12194000	Knee Pad SIP 435x195x30 mm, foam EVA, black /red	10,20 EUR
99B		20837515	Torque Key JMP 3/8", 20-110 Nm L=403 mm	70,00 EUR
99B		20837522	Combination Wrench Set JMP chrome-vanadium-steel, 6,7,8.. ,9,10,11,12,13,14,17,19,22 mm, 12-parts	57,00 EUR
99B		90982000	Tool Kit wrench 7/8 8/11 regular, phillips screwdriver, spark plug wrench 21/13	15,00 EUR
99B		90970410	Tool Bag SIP Classic, 640 mm, 270 cm, nylon, black, empty, w/o tools Grade AA - for a first-class repair	29,00 EUR

99B		20837521	Open-End Wrench Set JMP chrome-vanadium-steel, 6/7, 8 /9, 10/11, 12/13, 14/15, 16 /17, 18/19, 20/22 mm, 8-parts	35,00 EUR
99B		20837519	Set of Socket Spanners JMP 1/2", chrome-vanadium-steel, plastic case, 29 parts	99,00 EUR
99B		20837517	Allen Wrench Set JMP 1,5/2/2,5/3/4/5/6/8/10 mm, with ball end, 9 parts	27,00 EUR
99B		20837518	Set of Socket Spanners JMP 1/4", chrome-vanadium-steel, plastic case, 46 parts	85,00 EUR
99B		20837523	Pliers Set KNIPEX universal pliers/wire cutter /water pump pliers, 3 parts	75,00 EUR
99B		12194100	Floor Mat SIP 3 in 1 1210x420x30 mm, foam EVA, black/red, knee pad, cushion and floor mat all in one	24,90 EUR